



# Accelerated cryo-EM-guided determination of three-dimensional RNA-only structures

Kalli Kappel<sup>1,8</sup>, Kaiming Zhang<sup>1,2,8</sup>, Zhaoming Su<sup>2,6,8</sup>, Andrew M. Watkins<sup>3</sup>, Wipapat Kladwang<sup>3</sup>, Shanshan Li<sup>1,2</sup>, Grigore Pintilie<sup>1,2</sup>, Ved V. Topkar<sup>1</sup>, Ramya Rangan<sup>1</sup>, Ivan N. Zheludev<sup>1,3</sup>, Joseph D. Yesselman<sup>3,7</sup>, Wah Chiu<sup>1,2,4</sup>✉ and Rhiju Das<sup>1,3,5</sup>✉

**The discovery and design of biologically important RNA molecules is outpacing three-dimensional structural characterization. Here, we demonstrate that cryo-electron microscopy can routinely resolve maps of RNA-only systems and that these maps enable subnanometer-resolution coordinate estimation when complemented with multidimensional chemical mapping and Rosetta DRRAFTER computational modeling. This hybrid 'Ribosolve' pipeline detects and falsifies homologies and conformational rearrangements in 11 previously unknown 119- to 338-nucleotide protein-free RNA structures: full-length *Tetrahymena* ribozyme, hc16 ligase with and without substrate, full-length *Vibrio cholerae* and *Fusobacterium nucleatum* glycine riboswitch aptamers with and without glycine, *Mycobacterium* SAM-IV riboswitch with and without S-adenosylmethionine, and the computer-designed ATP-TTR-3 aptamer with and without AMP. Simulation benchmarks, blind challenges, compensatory mutagenesis, cross-RNA homologies and internal controls demonstrate that Ribosolve can accurately resolve the global architectures of RNA molecules but does not resolve atomic details. These tests offer guidelines for making inferences in future RNA structural studies with similarly accelerated throughput.**

Many RNA molecules fold into intricate three-dimensional (3D) structures to perform essential biological and synthetic functions including regulating gene expression, sensing small molecules and catalyzing reactions, often without the aid of proteins or other partners<sup>1,2</sup>. It is estimated that more than 80% of the human genome is transcribed to RNA, while just 1.5% codes for proteins, but our knowledge of RNA structure lags far behind our knowledge of protein structure<sup>3,4</sup>. The Protein Data Bank, the repository for 3D structures, currently contains fewer than 1,500 RNA structures, compared with ~147,000 protein structures. Accurate models of RNAs could enhance our understanding of functional similarities between distantly related RNA sequences, enable visualization of the conformational rearrangements that accompany substrate and ligand binding, and accelerate our ability to design and evolve synthetic structured RNA molecules. However, the conformational heterogeneity of RNA molecules, particularly in the absence of protein partners, challenges conventional structure determination techniques such as X-ray crystallography and NMR<sup>5,6</sup>. Even when such techniques are applied, the process is laborious, time-consuming and requires extensive construct-specific optimization. Typically, publications have reported only one or two 3D RNA structures at a time (refs. <sup>5,7</sup> and references therein).

Single-particle cryo-electron microscopy (cryo-EM) may provide a new approach to RNA structure determination. Recent advances in the technique have enabled high-resolution structure determination of proteins and large RNA–protein complexes that previously could not be solved with X-ray crystallography or NMR<sup>8,9</sup>. However, it has been widely assumed that most functional

noncoding RNA molecules that are not part of large RNA–protein complexes are either too small or too conformationally heterogeneous to characterize with cryo-EM. When we began this study, there was only one published subnanometer-resolution cryo-EM map of an RNA molecule produced without protein partners, a 9 Å map of the 30-kDa HIV-1 dimerization initiation signal (DIS), and extensive NMR measurements were needed to model the molecule's atomic coordinates<sup>10</sup>, consistent with the general view that cryo-EM is ill-suited to structurally characterize RNA. Here, we present a large-scale study that challenges this view, showing instead that RNA-only structure determination can be relatively rapid and routine with cryo-EM when pipelined with high-throughput biochemistry and computational 3D structure modeling (Fig. 1a).

## Results

**Computational modeling accurately builds RNA coordinates into cryo-EM maps.** As an initial proof of concept, we performed a blind test of whether cryo-EM-guided computer reconstructions might obviate NMR experiments using the 9-Å-resolution HIV-1 DIS map. Before the publication of the HIV-1 DIS structure, K.K., A.M.W. and R.D. built all-atom models into the 9 Å map using a modified version of DRRAFTER, a recently developed Rosetta computational tool for modeling RNA coordinates into moderate-resolution density maps (see Methods)<sup>11</sup> (Fig. 1b). K.Z. and W.C. kept the coordinates derived from NMR restraints hidden while predictions were being made. In addition to building DRRAFTER models, we used the previously established linear relationship between model root mean squared deviation (r.m.s.d.)

<sup>1</sup>Biophysics Program, Stanford University, Stanford, CA, USA. <sup>2</sup>Department of Bioengineering, James H. Clark Center, Stanford University, Stanford, CA, USA. <sup>3</sup>Department of Biochemistry, Stanford University, Stanford, CA, USA. <sup>4</sup>Division of CryoEM and Bioimaging, SSRL, SLAC National Accelerator Laboratory, Stanford University, Menlo Park, CA, USA. <sup>5</sup>Department of Physics, Stanford University, Stanford, CA, USA. <sup>6</sup>Present address: The State Key Laboratory of Biotherapy, West China Hospital, Sichuan University, Sichuan, China. <sup>7</sup>Present address: Department of Chemistry, University of Nebraska-Lincoln, Lincoln, NE, USA. <sup>8</sup>These authors contributed equally: Kalli Kappel, Kaiming Zhang, Zhaoming Su. ✉e-mail: [wahc@stanford.edu](mailto:wahc@stanford.edu); [rhiju@stanford.edu](mailto:rhiju@stanford.edu)

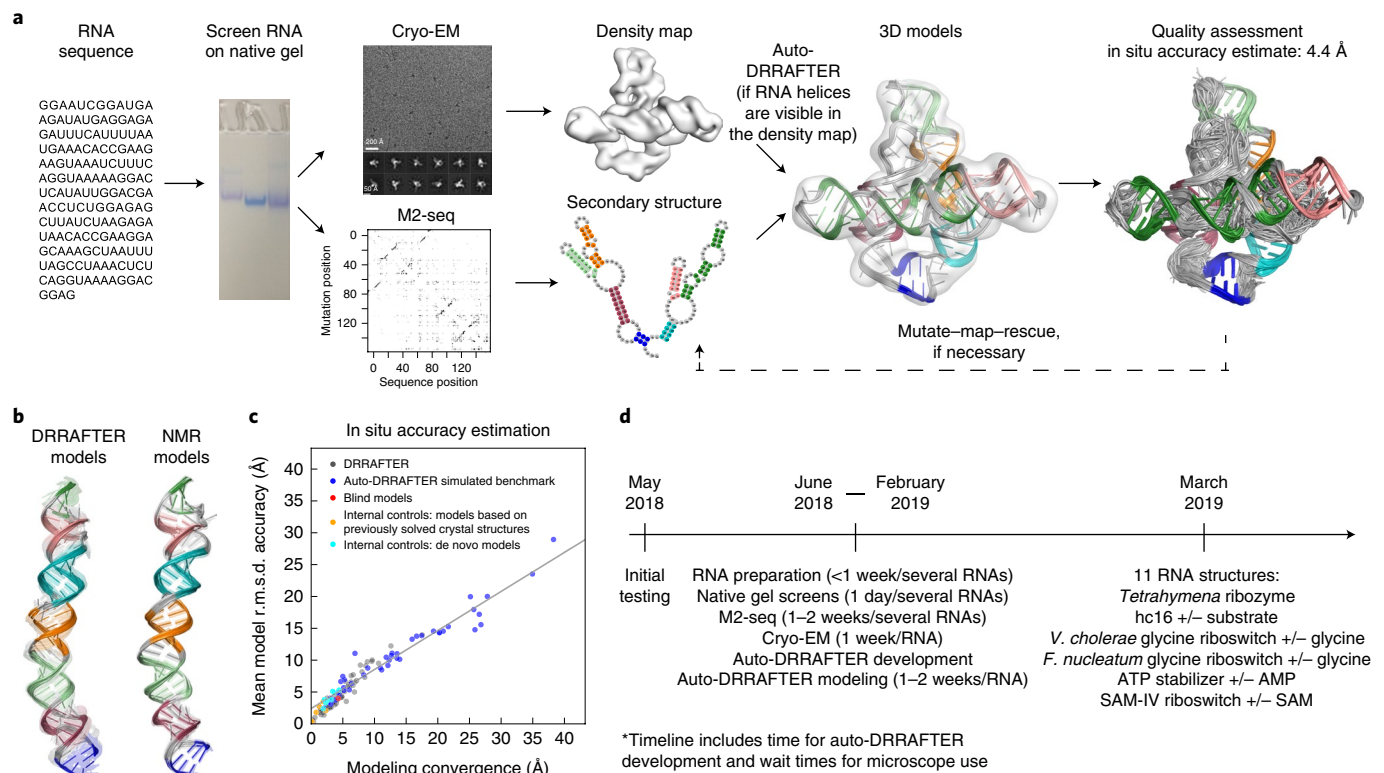

**Fig. 1 | The Ribosolve pipeline.** RNA structure determination through cryo-EM, M2-seq and computational modeling. **a**, RNA samples are prepared and screened on a native gel to check for the formation of sharp bands. M2-seq experiments are performed to elucidate the RNA secondary structure. Cryo-EM elucidates the global architecture of the RNA. The M2-seq-based secondary structure and cryo-EM map are used to build all-atom models with auto-DRRAFTER. Model accuracy is predicted from the overall modeling convergence. Helical regions of the 3D models are colored to match the secondary structure diagram. **b**, Blind HIV-1 DIS DRRAFTER models (left) and NMR models (right). Each helix is depicted with a different bright color. Junctions are colored gray. **c**, Mean model r.m.s.d. accuracy over the top-ten-scoring models versus modeling convergence for models after each round of auto-DRRAFTER for the benchmark on simulated maps (blue), DIS blind models (red), DRRAFTER models (gray)<sup>11</sup>, and *F. nucleatum* and *V. cholerae* glycine riboswitch, *Tetrahymena* ribozyme, SAM-IV riboswitch, THF riboswitch and *B. subtilis* T-box-tRNA complex Ribosolve models built into experimental density maps (internal controls, orange and cyan; see Supplementary Table 4). **d**, Timeline for Ribosolve structure determination in this study.

accuracy and modeling convergence, defined as the average pairwise r.m.s.d. across the top-ten-scoring DRRAFTER models, to predict that the models would have mean r.m.s.d. accuracy of 4.3 Å (gray points, Fig. 1c; and see “Auto-DRRAFTER automatically models RNA coordinates into cryo-EM maps” below)<sup>11</sup>. Indeed, the blind DRRAFTER models agreed well with the NMR models, with mean r.m.s.d. accuracy of 4.0 Å (Fig. 1b).

**A benchmark set of RNA molecules with previously unknown structures.** To more broadly benchmark this cryo-EM-DRRAFTER pipeline, we selected a set of 18 functionally diverse RNA molecules ranging in size from 65 to 388 nucleotides (21–126 kDa). The complete structures of these molecules were unknown, and up to 15 were expected to have well-defined 3D structures based on the functions they are known to perform. These RNAs broadly fell into three functional classes: ribozymes, riboswitches and computationally designed RNAs. The ribozymes include the L-21 ScaI ribozyme from *Tetrahymena thermophila*, which catalyzes a splicing reaction<sup>12</sup>; the in vitro-selected hc16 RNA ligase in an apo state and after ligation of an RNA substrate to its 5' end (“hc16 product”)<sup>13</sup>; and the 24-3 ribozyme, an in vitro-selected RNA polymerase that replicates short RNA sequences<sup>14</sup>. The riboswitches, which regulate gene expression by sensing specific small-molecule substrates, include the *V. cholerae* and *E. nucleatum* glycine riboswitch aptamers with and without glycine<sup>15</sup>, a metagenome-derived SAM-IV riboswitch with and without S-adenosylmethionine (SAM)<sup>16</sup> and a metagenome-derived downstream peptide (glutamine-II)

riboswitch with glutamine<sup>17</sup>. The computationally designed synthetic RNA constructs include ATP-TTR-3, a stabilized aptamer for ATP and AMP<sup>18</sup>, both with and without AMP; spinach-TTR-3, a stabilized version of the spinach aptamer<sup>18</sup>, which fluoresces when bound to DFHBI (3,5-difluoro-4-hydroxybenzylidene imidazolinone)<sup>19</sup>; and a molecule developed with a prototype 3D design interface in the Eterna online game, eterna3D-JR\_1 (see Supplementary Fig. 1)<sup>20</sup>. Parts of the glycine riboswitches and *Tetrahymena* ribozyme were previously structurally characterized and therefore served as internal positive controls<sup>21–23</sup>. All of these molecules contained substantial portions of unknown structure, in some cases after decades of attempts with earlier methods<sup>22,24</sup>. As negative controls, we also included three molecules that were not expected to adopt well-defined 3D structures: the human small Cajal body-specific RNA 6 (scaRNA6) and the human spliceosomal U1 small nuclear RNA (snRNA), both of which function as part of larger RNA-protein complexes<sup>25,26</sup> without any known RNA-RNA tertiary contacts and are therefore unlikely to be highly structured in the absence of their protein binding partners; and the human Retinoblastoma 1 (RB1) 5' untranslated region (UTR), which has previously been shown to adopt multiple secondary structures<sup>27</sup>.

**Cryo-EM resolves the global folds of RNA molecules.** After screening all RNA molecules by native gel electrophoresis (Supplementary Results, Extended Data Fig. 1 and Fig. 1a), we applied single-particle cryo-EM, seeking to resolve their 3D folds (Fig. 2 and Extended Data Fig. 2). All samples were initially screened

on a Talos Arctica cryo-electron microscope to check that particles of homogeneous composition and expected size were visible. For each sample, approximately 600–1,000 micrographs were then collected with either a Talos Arctica or Titan Krios cryo-electron microscope. Most of these data were collected with a Volta phase plate to improve RNA particle visibility (Supplementary Table 1). The data were processed using standard cryo-EM data-processing software (Extended Data Fig. 3 and see Methods). Two-dimensional (2D) class averages and 3D reconstructions for all RNAs are shown in Extended Data Fig. 4. For a subset of RNAs for which the resulting 3D reconstructions exhibited distinct RNA-like features such as major and/or minor helical grooves, we collected more data, up to 6,600 micrographs per specimen, to try to improve the map resolution (Supplementary Table 1). Detailed descriptions of the cryo-EM sample preparation, data collection and data processing are provided in the Methods section.

As expected, we did not resolve the global folds of the three negative controls, which were predicted to not form well-defined tertiary structures (Fig. 2p–r). Additionally, native gels and 2D class averages of particle images suggested that the downstream peptide riboswitch, 24-3 ribozyme, spinach-TTR-3 and Eterna3D-JR\_1 would exhibit substantial conformational flexibility in standard buffer conditions for *in vitro* RNA assembly (Extended Data Fig. 1 and Fig. 2). Indeed, we did not resolve the global folds of these molecules with cryo-EM (Extended Data Fig. 4). We were able to determine maps of the remaining 11 molecules in our benchmark set (Fig. 2). The final map resolutions ranged from 4.7 to 11 Å (Supplementary Table 1 and Extended Data Fig. 5) and exhibited several distinctive characteristics of RNA molecules. All density maps contained rod-like shapes with dimensions concordant with RNA helices (~20 Å diameter; scale bar in Fig. 2a). Major grooves were visible in all maps (Fig. 2, blue arrows) and minor grooves were visible in seven maps (Fig. 2, red arrows). The relative sizes of the resolved molecules varied in accordance with the lengths of the RNA sequences; the *Tetrahymena* ribozyme map is the largest, while the SAM-IV riboswitch map is the smallest (Fig. 2). Additionally, these maps exhibit several more complex features that were not present in the previously determined 9 Å HIV-1 DIS map<sup>10</sup>, such as pockets and holes unique to each RNA. To obtain more-detailed insights into these structural features, we sought to model atomic coordinates into the density maps.

**Auto-DRRAFTER automatically models RNA coordinates into cryo-EM maps.** Our preparatory blind tests on the HIV-1 DIS map suggested that we could apply computational modeling to build RNA coordinates into these more-intricate cryo-EM maps and estimate their accuracy. We therefore generalized the Rosetta DRRAFTER method to automatically model coordinates into moderate-resolution maps of RNA molecules. This method previously required user-assigned protein and RNA helix landmarks to initialize coordinates. Here, to help reduce bias, we developed an iterative procedure to automatically search for global helix placements in RNA-only cryo-EM maps, called auto-DRRAFTER (Extended Data Fig. 6). Briefly, starting from an RNA sequence, secondary structure and cryo-EM map, at least one RNA helix was automatically placed in the density map. The rest of the RNA structure was then built into the density map through fragment-based RNA folding. Analogous to hybrid modeling methods in protein structure prediction<sup>28,29</sup>, iterative modeling was performed in several rounds. Hundreds to thousands of models were built in each round, then automatically checked region-by-region for structural consensus across top-scoring models. Regions with sufficient consensus were then kept fixed in the next round. This automated process was continued until the entire structure could be confidently built. Final refinement was carried out in two independent cryo-EM maps generated from separate halves of the cryo-EM data (Methods).

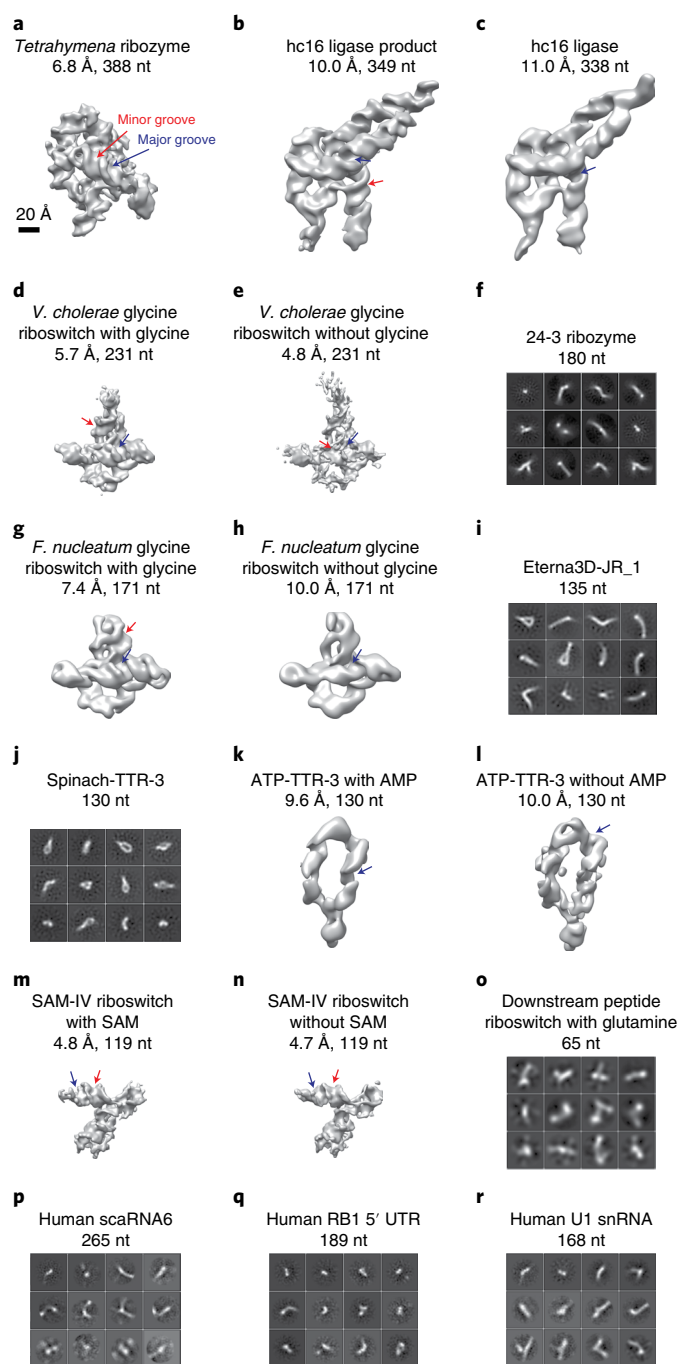

**Fig. 2 | Cryo-EM maps for RNA-only systems. a–o,** Cryo-EM 2D class averages or 3D reconstructions for ribozymes, riboswitch aptamers and synthetic RNA nanostructures, arranged in order of RNA size, largest to smallest: **a**, *Tetrahymena* ribozyme, **b**, hc16 ligase product, **c**, hc16 ligase, **d**, *V. cholerae* glycine riboswitch with glycine, **e**, *V. cholerae* glycine riboswitch without glycine, **f**, 24-3 ribozyme, **g**, *F. nucleatum* glycine riboswitch with glycine, **h**, *F. nucleatum* glycine riboswitch without glycine, **i**, Eterna3D-JR\_1, **j**, Spinach-TTR-3, **k**, ATP-TTR-3 with AMP, **l**, ATP-TTR-3 without AMP, **m**, SAM-IV riboswitch with SAM, **n**, SAM-IV riboswitch without SAM, **o**, downstream peptide riboswitch with glutamine. **p–r**, 2D class averages for negative controls: **p**, human scaRNA6, **q**, human RB1 5' UTR, **r**, human U1 snRNA. 2D classification was performed once for each sample (see Methods). All maps are shown at the same scale. Representative micrographs are shown in Extended Data Fig. 2. 2D class averages and 3D reconstructions for all RNAs are shown in Extended Data Fig. 4. nt, nucleotides.

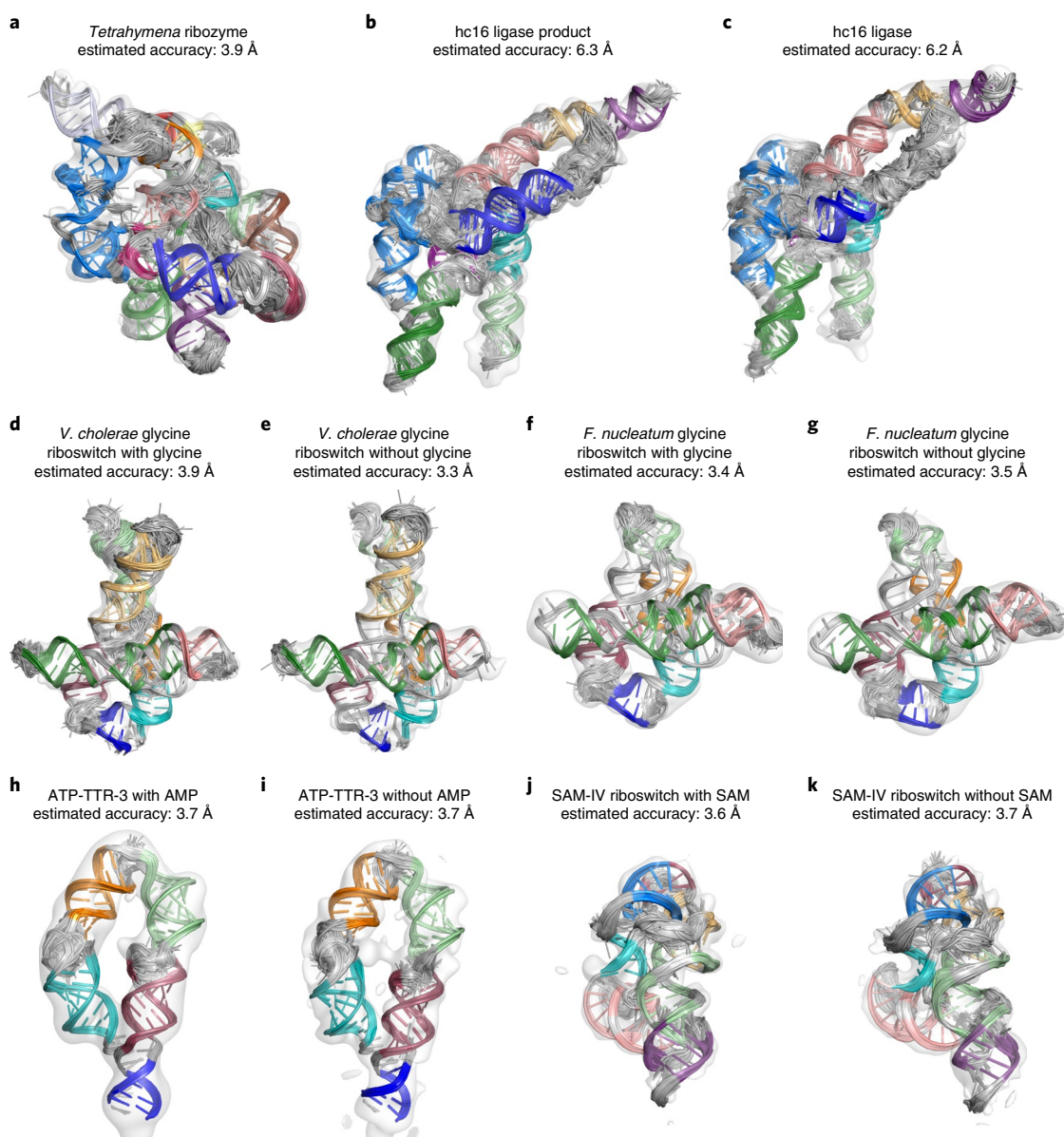

**Fig. 3 | RNA structures determined by the Ribosolve pipeline. a–k,** Top scoring auto-DRRAFTER models in the cryo-EM maps and estimated accuracies based on modeling convergence for **a**, *Tetrahymena* ribozyme, **b**, hc16 ligase product, **c**, hc16 ligase, **d**, *V. cholerae* glycine riboswitch with glycine, **e**, *V. cholerae* glycine riboswitch without glycine, **f**, *F. nucleatum* glycine riboswitch with glycine, **g**, *F. nucleatum* glycine riboswitch without glycine, **h**, ATP-TTR-3 with AMP, **i**, ATP-TTR-3 without AMP, **j**, SAM-IV riboswitch with SAM, and **k**, SAM-IV riboswitch without SAM. Each helix is depicted with a different bright color. Nonhelical regions are colored gray.

The complete details of the auto-DRRAFTER modeling procedure are described in the Methods and Supplementary Note 4. To elucidate or confirm RNA secondary structures needed for auto-DRRAFTER, we used mutate-and-map read out by next-generation sequencing (M2-seq)<sup>30</sup> (Supplementary Results and Extended Data Figs. 7–9). Two sets of models were built for each RNA, either with the secondary structures automatically derived from the M2-seq data or with secondary structures modified based on sequence covariation information or previously solved crystal structures (Extended Data Fig. 8). Additional details are provided in the Methods. Tests using simulated density maps of eight RNAs of known structure suggested that auto-DRRAFTER models would be accurate (Extended Data Fig. 10, Supplementary Fig. 2, Supplementary Table 2 and Supplementary Results). Models built into the experimental crystallographic density were similarly accurate (Extended Data Fig. 10i). As an additional test of auto-DRRAFTER performance

on experimental density maps, we built models into the recently determined 4.9 Å map of the *Bacillus subtilis* T-box-transfer RNA complex<sup>31</sup> (Extended Data Fig. 10j). The accuracy of these auto-DRRAFTER models (r.m.s.d. = 5.3 Å) was similar to models built into simulated maps (r.m.s.d. values of 2.5 Å to 11.1 Å). Additionally, these tests suggested that auto-DRRAFTER modeling convergence, defined as the average pairwise r.m.s.d. over the top-ten-scoring models, would be correlated with model r.m.s.d. accuracy, defined here as r.m.s.d. to the previously solved crystal structures (Pearson's correlation coefficient ( $r^2$ ) = 0.95, two-tailed  $P = 9 \times 10^{-29}$ ,  $N = 45$ ) (blue points, Fig. 1c). In studies below, we therefore used this linear relationship to estimate model accuracy from convergence (accuracy =  $0.61 \times$  convergence + 2.4 Å). This relationship agrees well with the previously determined relationship between DRRAFTER convergence and accuracy, based on RNA coordinates built into experimentally determined cryo-EM

**Table 1 | Estimated accuracy of Ribosolve models<sup>a</sup>**

System	Length (nt)	Final no. particles used for 3D reconstruction	Map resolution (Å)	Estimated accuracy <sup>a</sup> (Å)
<i>Tetrahymena</i> ribozyme	388	74,621	6.8	3.9
hc16 product	349	29,191	10.0	6.3
hc16	338	21,263	11.0	6.2
<i>V. cholerae</i> glycine riboswitch with glycine	231	193,317	5.7	3.9
<i>V. cholerae</i> glycine riboswitch apo	231	230,891	4.8	3.3
<i>F. nucleatum</i> glycine riboswitch with glycine	171	35,578	7.4	3.4
<i>F. nucleatum</i> glycine riboswitch apo	171	20,269	10.0	3.5
ATP-TTR-3 with AMP	130	39,136	9.6	3.7
ATP-TTR-3 apo	130	71,045	10.0	3.7
SAM-IV riboswitch with SAM	119	225,303	4.8	3.6
SAM-IV riboswitch apo	119	260,244	4.7	3.7

<sup>a</sup>Accuracy is estimated from the modeling convergence (accuracy = 0.61 × convergence + 2.4 Å), where convergence is defined as the average pairwise r.m.s.d. of the top-ten-scoring models built into half map 1 versus models built into half map 2 (see Methods).

maps of RNA–protein complexes (Fig. 1c)<sup>11</sup>. Importantly, these estimations suggest that although auto-DRRAFTER modeling always generates full atomic models, and these models are appropriate for archiving information, it is best in figures to depict the models with a ribbon-and-base pair representation to better reflect the uncertainty in positions of individual atoms.

**Eleven all-atom models from Ribosolve.** We gave the hybrid pipeline consisting of cryo-EM, M2-seq chemical mapping and auto-DRRAFTER computer modeling the name Ribosolve, and we tested it on the RNAs for which we had acquired confident cryo-EM maps with clearly visible major and/or minor helical grooves. In all cases, Ribosolve enabled us to build all-atom models, with estimated coordinate r.m.s.d. accuracies ranging from 3.3 to 6.3 Å as predicted from modeling convergence (Figs. 1c and 3, Table 1, Supplementary Table 3 and Supplementary Video 1). As further tests of model accuracy, we performed additional consistency checks for each of the Ribosolve structures.

The *F. nucleatum* and *V. cholerae* glycine riboswitch Ribosolve models agreed well with the previously solved crystal structures<sup>21,23</sup>, with mean r.m.s.d. values over the top-scoring models of 4.9 Å for the *F. nucleatum* glycine riboswitch with glycine and 3.3 and 3.6 Å for the *V. cholerae* glycine riboswitch with and without glycine, respectively (Fig. 4a,b). These accuracies agreed well with predicted accuracies for these models based on auto-DRRAFTER modeling convergence, supporting the relationship for accuracy estimation derived from simulation benchmarks (cyan, Fig. 1c). For the *Tetrahymena* ribozyme, models were built starting from the previously solved crystal structure of the core of the ribozyme. The complete *Tetrahymena* ribozyme Ribosolve models fit well in the density map (Fig. 4c,d and Supplementary Table 4).

For hc16 and the hc16 product, we confirmed that the Ribosolve models were consistent with all previous observations of the ribozyme<sup>13</sup>. First, the models exhibited the P7 and P9 helices, which each contain nucleotides that exhibited covariation in clones examined from the original in vitro selection experiments. Nucleotides that were invariant across the final in vitro-selected sequences are shown as red spheres in Fig. 4e and were all automatically modeled as near the substrate binding site or forming base pairs with regions of fixed sequence in the selection libraries. Nucleotides that were not conserved between sequences are shown as white spheres in Fig. 4e and did not make any interactions with other parts of the ribozyme in the Ribosolve model. Additionally, removing the 13 nucleotides at the 3' end of the ribozyme abolished its activity.

In the Ribosolve model, most of these nucleotides are part of the P10, P10-ext or P12 stems in the core of the structure.

The M2-seq data for the ATP-TTR-3 with and without AMP molecules contained features that were not explained by the M2-seq-derived secondary structures and appeared to correspond to tertiary contacts, providing additional information about nucleotides that should be close together in the 3D structures (Fig. 4f and Supplementary Fig. 3). We confirmed that our Ribosolve models, which were built without using this information, recovered these tertiary contacts (Fig. 4f and Supplementary Fig. 3).

Finally, we compared our SAM-IV riboswitch models with Ribosolve models built into higher-resolution density maps, which were obtained by collecting more data (3.7 Å for the apo state and 4.1 Å for the SAM-bound state)<sup>32</sup>. The models agreed well, with r.m.s.d. values of 3.8 Å for the apo state (Fig. 4g) and 2.5 Å for the SAM-bound state. Additionally, six nucleotides in the SAM-IV riboswitch were previously hypothesized to form the binding pocket for SAM<sup>16</sup>. We confirmed that these nucleotides were all located near each other in the fully automated apo SAM-IV Ribosolve models, which were not built using this information, and that the conformation of these nucleotides was in good agreement with the conformation of putatively homologous nucleotides in the previously solved crystal structure of the SAM-I riboswitch (r.m.s.d. = 3.3 Å; Fig. 4h). Additionally, the best-case models for SAM-IV with and without SAM, which were built using this homology (see Methods for details), agreed with the fully automated models (r.m.s.d. = 5.0 and 5.6 Å for best-case models with and without SAM, respectively, versus fully automated models without SAM).

The coordinate accuracy length scale achieved by Ribosolve (3.3–6.3 Å) is finer than the typical distance between backbone atoms in consecutive nucleotides and, historically, has been sufficient to attain nontrivial insights into whether RNAs of similar function have similar folds, how RNA structures respond to binding partners and whether designed RNA structures fold as predicted<sup>24,26,33,34</sup>. Each of the 11 Ribosolve models revealed at least one of these kinds of insights.

**Glycine riboswitches from different species adopt nearly identical folds.** The *F. nucleatum* and *V. cholerae* glycine riboswitches each contain two glycine aptamers that interact through tertiary contacts to form a butterfly-like fold (Figs. 3d–g and 5a)<sup>21,23</sup>. For both RNAs, we observed evidence of two features predicted from previous computational analysis, a P0 stem (Fig. 3d–g, blue) and a kink-turn formed between the 5' ends of each molecule and the linker between

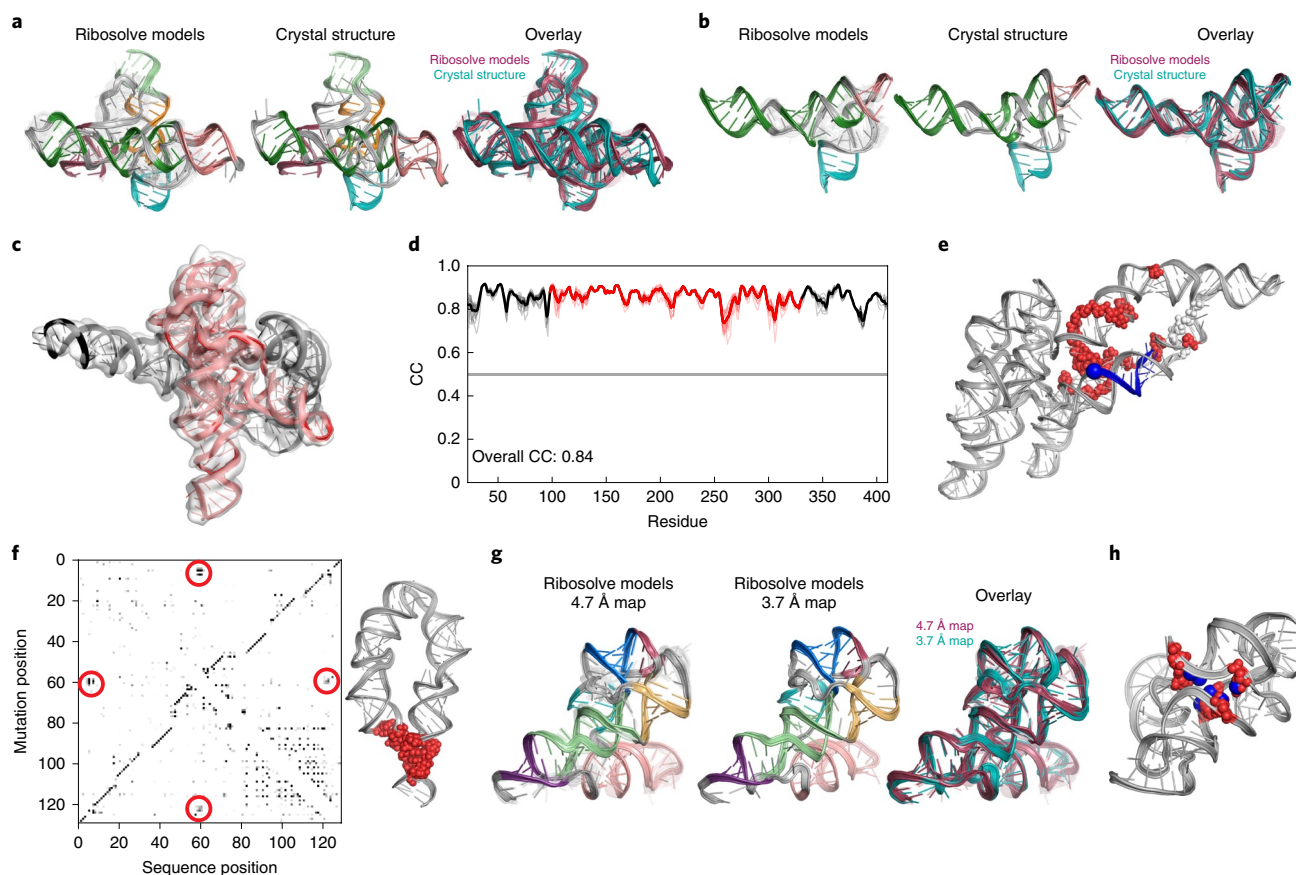

**Fig. 4 | Tests of Ribosome model accuracy.** **a, b**, Top-ten-scoring fully automated Ribosome models (left; models 2–10 are transparent; each helix depicted with a different bright color; nonhelical regions colored gray), previously solved crystal structures (middle; colors match Ribosome models) and overlay (right; Ribosome models colored pink; crystal structure colored cyan) for *F. nucleatum* glycine riboswitch (**a**) and *V. cholerae* glycine riboswitch (**b**). Note that auto-DRRAFTER models were built for the complete RNAs, but for clarity only the parts that correspond to the previously solved crystal structures are shown. **c**, The *Tetrahymena* ribozyme Ribosome model in the cryo-EM map. The region derived from a previously solved crystal structure is colored red and regions built de novo are colored black. **d**, Real-space correlation between the *Tetrahymena* ribozyme Ribosome models and cryo-EM map. Colors are the same as in **c**. Real-space correlation values for each of the top-ten-scoring models built into each half map are shown as thin lines; the average over all top-scoring models is plotted as a thick line ( $n=20$  independent models). **e**, The hc16 product Ribosome model. Invariant and highly variable residues across final sequences from the original *in vitro* selection<sup>13</sup> shown as red and white spheres, respectively. The site of substrate ligation, the phosphorus atom in residue 1, is shown as a large blue sphere. All other residues are colored gray. **f**, M2-seq z-score plots (left) with putative tertiary contacts circled in red and Ribosome models (right) with nucleotides corresponding to the circled regions in the z-score plots shown as red spheres for the ATP-TTR-3 with AMP ( $n=914,892$  sequences). **g**, The best-case SAM-IV apo state Ribosome models built into the 4.7 Å cryo-EM map determined here (left; models 2–10 are transparent; each helix depicted with a different bright color; nonhelical regions colored gray) and a 3.7 Å map<sup>32</sup> (middle; colors match Ribosome models). Models are shown overlaid on the right (Ribosome models built into the 4.7 and 3.7 Å maps colored pink and cyan, respectively). **h**, The fully automated SAM-IV apo state Ribosome model with nucleotides hypothesized to form the SAM binding pocket shown as red spheres. Homologous nucleotides taken from a previously solved SAM-I riboswitch structure (PDB ID: 2GIS) are overlaid and shown as blue spheres. CC, real-space correlation coefficient.

each molecule's two glycine aptamers<sup>35</sup>. In addition to the structural homology between the glycine riboswitches from different organisms, the two aptamers within each riboswitch also adopted nearly identical folds (Fig. 5a,b). Furthermore, for both riboswitches, the ligand-free states closely resemble the ligand-bound states (Fig. 3d–g). This invariance in tertiary fold upon ligand binding has been observed previously for other natural riboswitches and hypothesized for glycine riboswitches<sup>35,36</sup>, but was not established for these glycine riboswitches because sequences previously used for structure determination were over-truncated<sup>21,23</sup>.

**Distinct peripheral architectures support a conserved core structure across multiple classes of SAM riboswitches.** Ribosome revealed that the SAM-IV riboswitch aptamer adopts a complex fold with two pseudoknots (Fig. 3j,k). Comparison of this structure with previously solved crystal structures of SAM-I and SAM-I/IV

riboswitches showed that the tertiary structure is substantially rewired across the three classes of SAM riboswitches (Fig. 5c), but the core structures are nearly identical in all three molecules (Fig. 5d)<sup>37,38</sup>. These observations are consistent with previously hypothesized homology based on secondary structure<sup>37</sup>. Similar to the glycine riboswitches, the apo and holo SAM-IV riboswitch aptamer structures are highly similar (Fig. 3j,k).

**Assessing the model accuracy of computationally designed RNA molecules.** Beyond its application to determining structures of natural RNAs, Ribosome enabled rapid assessment of the synthetic ATP-TTR-3 structure. ATP-TTR-3 embeds the AMP aptamer into a clothespin-like scaffold, which was designed to pre-organize the aptamer structure and enhance its ligand binding affinity<sup>18</sup>, analogous to natural riboswitch aptamers, including the glycine and SAM riboswitches solved here (Fig. 3d–g,j,k). Automated Ribosome structures

of ATP-TTR-3 with and without AMP confirmed this pre-folding into the computer-designed tertiary structures within the estimated coordinate error (r.m.s.d. values of 4.2 and 4.3 Å, respectively) (Fig. 5e). Additionally, the ATP-TTR-3 Ribosolve structures with and without AMP are very similar (mean r.m.s.d. = 2.7 Å), further supporting the hypothesis that minimal conformational rearrangement occurs upon ligand binding (Fig. 5e).

**The complete global architecture of the *Tetrahymena* ribozyme and rearrangements of core elements in the hc16 ligase.** Ribosolve structures of our two largest molecules offered comparisons with literature predictions and with each other. First, the *Tetrahymena* ribozyme is a paradigmatic RNA enzyme discovered 38 yr ago and manually modeled 24 yr ago<sup>39</sup> (Fig. 3a). Peripheral elements of the ribozyme, P2, P2.1, P9.2, P9.1, P13 and P14, are resolved here; these elements wrap around the core of the ribozyme, to complete a ring around its catalytic core, substantiating a decades-old qualitative prediction (Fig. 5f), while also revealing large holes in the structure that were not previously predicted (Fig. 5f, arrows)<sup>39</sup>. Second, the hc16 ribozyme is a ligase evolved in vitro from a random library that contained the P4-P6/P3-P8 domain of the *Tetrahymena* ribozyme as a constant scaffold region<sup>13</sup>; it was expected that the architecture of the hc16 ligase would be very similar to the *Tetrahymena* ribozyme. Instead, the hc16 Ribosolve structure exhibits a unique extended conformation that has not yet been observed in other ribozyme structures (Fig. 3b,c). In both the structures without substrate and with ligated substrate, the active site is at the center of the hc16 molecule and the substrate-binding segment is positioned similarly to the string of a bow (Fig. 5g). This rearrangement of the hc16 ligase from its 'parent' *Tetrahymena* ribozyme, while unexpected, provides a rationalization for observations in sequence conservation data for hc16<sup>13</sup>, is consistent with new chemical mapping data for the RNA (Supplementary Results and Supplementary Fig. 4) and provides an illustration of how structure modeling enabled by Ribosolve can refine structure–function–homology relationships.

**Limitations of the Ribosolve pipeline.** Ribosolve has advantages over previous RNA-only structure determination techniques, most notably, the relative speed and ease with which the technique can be applied and its applicability to RNA molecules that have been

refractory to crystallography and NMR, such as the *Tetrahymena* ribozyme. However, when applying Ribosolve, it is important to be mindful of its limitations (Fig. 6). First, although Ribosolve always produces an ensemble of all-atom models, it does not provide atomic-scale structural detail (Fig. 6a). We do not expect even the most highly converged Ribosolve models to correctly position all atoms. Such models may contain register shifts or other systematic inaccuracies. Ensembles of several independently generated models, visualized as ribbons rather than as atom-level coordinates,

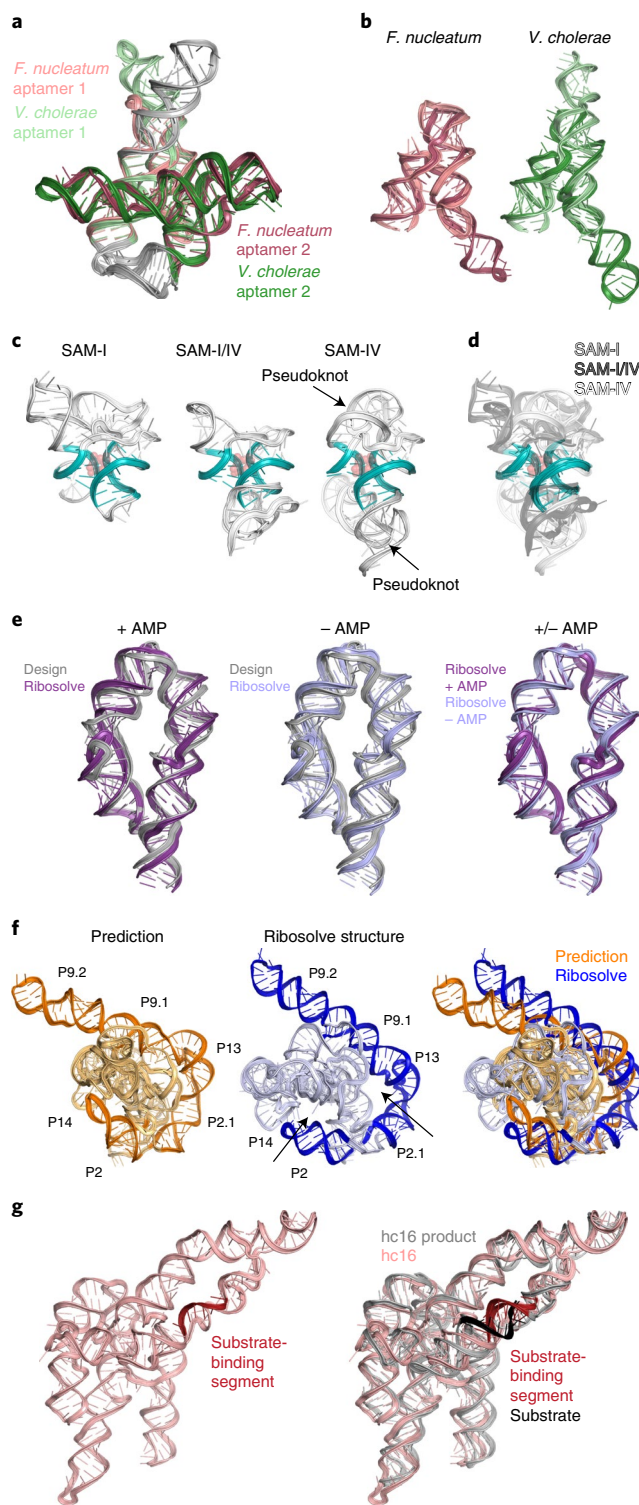

**Fig. 5 | Functional insights from Ribosolve models. a**, Overlay of *V. cholerae* and *F. nucleatum* glycine riboswitches with glycine. Aptamer 1 is colored light pink and light green for the *F. nucleatum* and *V. cholerae* glycine riboswitches, respectively. Aptamer 2 is colored pink and green for the *F. nucleatum* and *V. cholerae* glycine riboswitches, respectively. **b**, Overlay of both glycine aptamers from the *F. nucleatum* and *V. cholerae* structures. Models are colored as in **a**. **c,d**, Structural homology between the SAM-IV riboswitch and SAM-I and SAM-I/IV riboswitches. **c**, The SAM-I crystal structure<sup>38</sup>, the SAM-I/IV crystal structure<sup>37</sup> and the SAM-IV Ribosolve model. **d**, An overlay of all three structures, with the core colored cyan and peripheral elements shown as gray transparent ribbons. SAM is shown as transparent red spheres. **e**, Comparisons of Ribosolve structures for ATP-TTR-3 with and without AMP, colored dark and light purple, respectively, and the computationally designed models, colored gray. **f**, The overall architecture of the previously predicted model of the *Tetrahymena* ribozyme<sup>39</sup> (core and peripheral elements colored light orange and orange, respectively) qualitatively matches the Ribosolve structure (core and peripheral elements colored light blue and blue, respectively), with peripheral elements wrapping around the core. The Ribosolve structure contains holes (arrows in middle panel) not present in the predicted structure. **g**, Comparison of the hc16 Ribosolve structures without substrate (pink) and with ligated substrate (gray). The substrate-binding segment and substrate are highlighted in red and black, respectively.

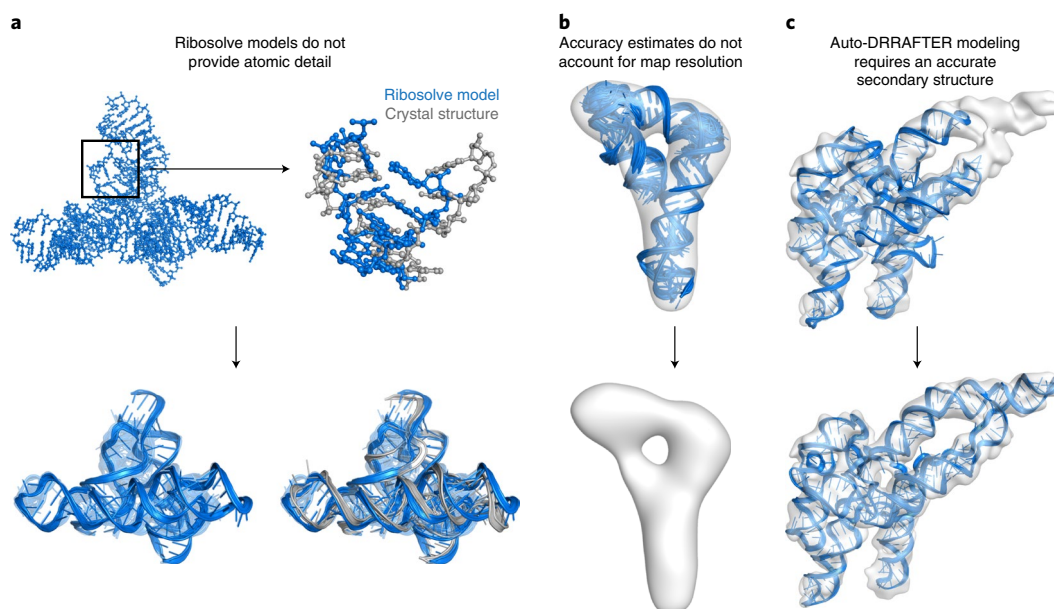

**Fig. 6 | Limitations of the Ribosolve pipeline.** **a**, Though Ribosolve produces all-atom models, it does not provide atomic resolution detail. Indeed, the atomic details of Ribosolve models are often incorrect (top right). A ribbon-and-base pair representation of the ensemble of top-scoring models (below) better depicts the approximately nucleotide-resolution of most Ribosolve models. The *F. nucleatum* glycine riboswitch with glycine is shown here. Ribosolve models are colored blue and the previously solved crystal structure is colored gray. Regions of the Ribosolve models that were not previously crystallized are not shown for clarity. **b**, Highly converged Eterna3D-JR\_1 models built into a 14 Å density map. The estimated accuracy of these models is 3.9 Å, but does not account for additional uncertainty due to the poor resolution of the density map. We do not recommend building models into density maps that do not contain visually identifiable RNA helices. **c**, Top, models of the hc16 product built with the incorrect secondary structure do not fit well in the density map. Bottom, with the correct secondary structure, auto-DRRAFTER builds models that fit well in the density map. Models are colored blue and maps colored gray in **b** and **c**.

should be reported to convey the precision of the method. Accuracy estimates based on this model convergence place additional bounds on the level of structural detail that should be interpreted. Second, because Ribosolve accuracy estimates do not take map resolution into account, we caution against building models into maps that do not clearly exhibit RNA-like features, particularly major and/or minor helical grooves. These models may still converge tightly, resulting in underestimation of model uncertainty. To illustrate this limitation, we built models into a 12 Å Spinach-TTR-3 map and a 14 Å Eterna3D-JR\_1 map generated from the data collected for these systems, for which the 2D class averages exhibited substantial heterogeneity and the 3D reconstructions did not show obvious RNA features (Extended Data Fig. 4). In each case, the models converged tightly, resulting in putative accuracy estimates of 4.2 Å for Spinach-TTR-3 and 3.9 Å for Eterna3D-JR\_1 (Fig. 6b). These accuracy estimates are similar to those for our other 11 Ribosolve models, despite the additional uncertainty arising from the lower-resolution maps. Furthermore, the models for Eterna3D-JR\_1 do not contain a tertiary contact for which there is evidence in the M2-seq data (Extended Data Fig. 7), suggesting that these models may be inaccurate. A third limitation of the Ribosolve pipeline results from the fact that auto-DRRAFTER modeling relies on accurate secondary structure information. Models built with inaccurate secondary structures can often be identified by visual inspection<sup>11</sup>. For example, models of hc16 built with the incorrect secondary structure did not fit well in the density map (Fig. 6c). In these cases, additional mutate-map-rescue experiments<sup>40,41</sup> may be required to determine and/or validate the correct secondary structure. Finally, Ribosolve models should always be independently validated. Here, we validated each model by comparing with crystallographic conformations of substructures, by comparing with functional and/or biochemical data or by performing mutate-map-rescue experiments (Fig. 4). The necessary validation will depend both on the system and on the questions being asked.

Many of these limitations could potentially be resolved by improving the cryo-EM map resolution. The main RNA features visible in the cryo-EM maps resolved here (all maps are >4 Å resolution) are overall fold and major and minor grooves, which enable visualization of conformational rearrangements and structural homology, and validation of designed structures. At higher resolution more-detailed features would be visible. Around 3–4 Å resolution, some base pairs might be visible, but the connectivity of the backbone is typically less clear. At approximately 3.0 Å resolution, individual RNA bases, base pairs, phosphates and metal ions might be visible. At this resolution, atomic details could be inferred, enabling detailed visualization of noncanonical interactions and interactions with small molecules. On one hand, such resolution might be achieved with more data. There is a correlation between the amount of cryo-EM data collected and the final map resolution ( $r^2=0.82$  for map resolution versus number of particles, two-tailed  $P=0.0001$ ,  $N=11$ ), suggesting that the resolution of many of these maps could possibly be improved by collecting more data. Indeed, we showed that the maps of the SAM-IV riboswitch with and without SAM could be improved from 4.8 and 4.7 Å to 4.1 and 3.7 Å, respectively<sup>32</sup>. On the other hand, even with the higher-resolution SAM-IV maps, for which the B-factors were the smallest of all the RNAs in this study (Supplementary Table 1), auto-DRRAFTER was still used to build models because manual coordinate modeling was not possible. In this case, substantial further improvement in map resolution was not easily achievable because it would require approximately 50× the number of particles to get a 3.0-Å-resolution map for SAM-IV<sup>32</sup>. For other RNAs in this study, such improvement in map resolution may require even more data, up to 50–1,000 times the current amount. As application of cryo-EM to RNA-only systems becomes more common, it is possible that some maps will reach resolutions of 3 Å or better, but we also expect that many maps will be in the resolution range where the full Ribosolve pipeline, including M2-seq and auto-DRRAFTER modeling, will be required.



## Discussion

The Ribosolve pipeline combines recent advances in cryo-EM, M2-seq biochemical analysis and Rosetta auto-DRRAFTER computer modeling to accelerate 3D RNA structure determination. Using this method, we determined 3D models of 11 RNA molecules, including riboswitches, ribozymes and synthetic RNA nanostructures, over the timescale of months (Fig. 1d). Several independent tests including a blind challenge, internal controls that had been previously solved by crystallography and independent biochemical experiments validate and confirm the Ribosolve models. The resolution, while not reaching atomic precision, is sufficient to reveal global tertiary structural features, to detect structural rearrangements upon target binding, to confirm or refute hypotheses of homology between RNA classes and to validate structure predictions for designed nanostructures. Use of the Rosetta auto-DRRAFTER tool, rather than manual coordinate modeling, accelerates model building into maps and also enables estimation of model accuracy from modeling convergence. Studies on the T-box and SAM-IV riboswitches from our group occurring in parallel or as follow-up to this work further support the utility and accuracy of cryo-EM and automated modeling to solve RNA 3D structures<sup>31,32</sup>. Important frontiers for Ribosolve include inference of RNA conformational ensembles rather than single dominant conformations<sup>42</sup>; automatic refinement of RNA secondary structures during 3D model building, which may obviate M2-seq experiments; acceleration of auto-DRRAFTER, which will be needed for completely automatic modeling of larger RNA assemblies; model refinement techniques to improve the accuracy of Ribosolve models; systematic benchmarking of the relationship between the amount of cryo-EM data collected and final map resolution for RNA-only systems; and systematic tests of RNAs with a wider range of lengths and varying numbers of tertiary contacts.

## Online content

Any methods, additional references, Nature Research reporting summaries, source data, extended data, supplementary information, acknowledgements, peer review information; details of author contributions and competing interests; and statements of data and code availability are available at <https://doi.org/10.1038/s41592-020-0878-9>.

Received: 4 December 2019; Accepted: 20 May 2020;

Published online: 2 July 2020

## References

- Atkins, J. F., Gesteland, R. F. & Cech, T. RNA Worlds: *From Life's Origins to Diversity in Gene Regulation* (Cold Spring Harbor Laboratory Press, 2011).
- Cech, T. R. & Steitz, J. A. The noncoding RNA revolution—trashing old rules to forge new ones. *Cell* **157**, 77–94 (2014).
- Lander, E. S. et al. Initial sequencing and analysis of the human genome. *Nature* **409**, 860–921 (2001).
- Hanguer, M. J., Vaughn, I. W. & McManus, M. T. Pervasive transcription of the human genome produces thousands of previously unidentified long intergenic noncoding RNAs. *PLoS Genet.* **9**, e1003569 (2013).
- Zhang, J. W. & Ferre-D'Amare, A. R. New molecular engineering approaches for crystallographic studies of large RNAs. *Curr. Opin. Struct. Biol.* **26**, 9–15 (2014).
- Zhang, H. & Keane, S. C. Advances that facilitate the study of large RNA structure and dynamics by nuclear magnetic resonance spectroscopy. *Wiley Interdiscip. Rev. RNA* **10**, e1541 (2019).
- Bergfors, T. Screening and optimization methods for nonautomated crystallization laboratories. *Methods Mol. Biol.* **363**, 131–151 (2007).
- McMullan, G., Faruqi, A. R., Clare, D. & Henderson, R. Comparison of optimal performance at 300 keV of three direct electron detectors for use in low dose electron microscopy. *Ultramicroscopy* **147**, 156–163 (2014).
- Ognjenovic, J., Grishammer, R. & Subramaniam, S. Frontiers in cryo electron microscopy of complex macromolecular assemblies. *Annu. Rev. Biomed. Eng.* **21**, 395–415 (2019).
- Zhang, K. M. et al. Structure of the 30 kDa HIV-1 RNA dimerization signal by a hybrid Cryo-EM, NMR, and molecular dynamics approach. *Structure* **26**, 490–498.e3 (2018).
- Kappel, K. et al. De novo computational RNA modeling into cryo-EM maps of large ribonucleoprotein complexes. *Nat. Methods* **15**, 947 (2018).

- Kruger, K. et al. Self-splicing RNA: autoexcision and autocyclization of the ribosomal RNA intervening sequence of *Tetrahymena*. *Cell* **31**, 147–157 (1982).
- Jaeger, L., Wright, M. C. & Joyce, G. F. A complex ligase ribozyme evolved in vitro from a group I ribozyme domain. *Proc. Natl Acad. Sci. USA* **96**, 14712–14717 (1999).
- Horning, D. P. & Joyce, G. F. Amplification of RNA by an RNA polymerase ribozyme. *Proc. Natl Acad. Sci. USA* **113**, 9786–9791 (2016).
- Mandal, M. et al. A glycine-dependent riboswitch that uses cooperative binding to control gene expression. *Science* **306**, 275–279 (2004).
- Weinberg, Z. et al. The aptamer core of SAM-IV riboswitches mimics the ligand-binding site of SAM-I riboswitches. *RNA* **14**, 822–828 (2008).
- Ames, T. D. & Breaker, R. R. Bacterial aptamers that selectively bind glutamine. *RNA Biol.* **8**, 82–89 (2011).
- Yesselman, J. D. et al. Computational design of three-dimensional RNA structure and function. *Nat. Nanotechnol.* **14**, 866–873 (2019).
- Paige, J. S., Wu, K. Y. & Jaffrey, S. R. RNA mimics of green fluorescent protein. *Science* **333**, 642–646 (2011).
- Lee, J. et al. RNA design rules from a massive open laboratory. *Proc. Natl Acad. Sci. USA* **111**, 2122–2127 (2014).
- Huang, L. L., Serganov, A. & Patel, D. J. Structural insights into ligand recognition by a sensing domain of the cooperative glycine riboswitch. *Mol. Cell* **40**, 774–786 (2010).
- Guo, F., Gooding, A. R. & Cech, T. R. Structure of the *Tetrahymena* ribozyme: base triple sandwich and metal ion at the active site. *Mol. Cell* **16**, 351–362 (2004).
- Butler, E. B., Xiong, Y., Wang, J. & Strobel, S. A. Structural basis of cooperative ligand binding by the glycine riboswitch. *Chem. Biol.* **18**, 293–298 (2011).
- Golden, B. L., Gooding, A. R., Podell, E. R. & Cech, T. R. A preorganized active site in the crystal structure of the *Tetrahymena* ribozyme. *Science* **282**, 259–264 (1998).
- Marz, M. et al. Animal snoRNAs and scaRNAs with exceptional structures. *RNA Biol.* **8**, 938–946 (2011).
- Krummel, D. A. P., Oubridge, C., Leung, A., Li, J. D. & Nagai, K. Crystal structure of a ten-subunit human spliceosomal U1 snRNP at 5.5 angstrom resolution. *Biophys. J.* **100**, 198–198 (2011).
- Kutchko, K. M. et al. Multiple conformations are a conserved and regulatory feature of the RB1 5' UTR. *RNA* **21**, 1274–1285 (2015).
- Russel, D. et al. Putting the pieces together: integrative modeling platform software for structure determination of macromolecular assemblies. *PLoS Biol.* **10**, e1001244 (2012).
- Ovchinnikov, S. et al. Large-scale determination of previously unsolved protein structures using evolutionary information. *eLife* **4**, e09248 (2015).
- Cheng, C. Y., Kladwang, W., Yesselman, J. D. & Das, R. RNA structure inference through chemical mapping after accidental or intentional mutations. *Proc. Natl Acad. Sci. USA* **114**, 9876–9881 (2017).
- Li, S. et al. Structural basis of amino acid surveillance by higher-order tRNA-mRNA interactions. *Nat. Struct. Mol. Biol.* **26**, 1094–1105 (2019).
- Zhang, K. et al. Cryo-EM structure of a 40-kDa SAM-IV riboswitch RNA at 3.7 Å resolution. *Nat. Commun.* **10**, 5511 (2019).
- Schmitt, E. et al. Structure of the ternary initiation complex eIF2-GDPNP-methionylated initiator tRNA. *Nat. Struct. Mol. Biol.* **19**, 450–454 (2012).
- Lane, S. W. et al. Construction and crystal structure of recombinant STNV capsids. *J. Mol. Biol.* **413**, 41–50 (2011).
- Kladwang, W., Chou, F. C. & Das, R. Automated RNA structure prediction uncovers a kink-turn linker in double glycine riboswitches. *J. Am. Chem. Soc.* **134**, 1404–1407 (2012).
- Cheng, C. Y. et al. Consistent global structures of complex RNA states through multidimensional chemical mapping. *eLife* **4**, e07600 (2015).
- Trausch, J. J. et al. Structural basis for diversity in the SAM clan of riboswitches. *Proc. Natl Acad. Sci. USA* **111**, 6624–6629 (2014).
- Montange, R. K. & Batey, R. T. Structure of the S-adenosylmethionine riboswitch regulatory mRNA element. *Nature* **441**, 1172–1175 (2006).
- Lehnert, V., Jaeger, L., Michel, F. & Westhof, E. New loop-loop tertiary interactions in self-splicing introns of subgroup IC and ID: a complete 3D model of the *Tetrahymena thermophila* ribozyme. *Chem. Biol.* **3**, 993–1009 (1996).
- Tian, S. Q., Cordero, P., Kladwang, W. & Das, R. High-throughput mutate-map-rescue evaluates SHAPE-directed RNA structure and uncovers excited states. *RNA* **20**, 1815–1826 (2014).
- Tian, S., Kladwang, W. & Das, R. Allosteric mechanism of the *V. vulnificus* adenine riboswitch resolved by four-dimensional chemical mapping. *eLife* **7**, e29602 (2018).
- Zhao, D. Q. & Jardetzky, O. An assessment of the precision and accuracy of protein structures determined by Nmr—dependence on distance errors. *J. Mol. Biol.* **239**, 601–607 (1994).

**Publisher's note** Springer Nature remains neutral with regard to jurisdictional claims in published maps and institutional affiliations.

© The Author(s), under exclusive licence to Springer Nature America, Inc. 2020

## Methods

**RNA preparation.** DNA templates for all molecules except *Tetrahymena* ribozyme were prepared by PCR assembly of DNA oligonucleotides designed with Primerize<sup>43</sup> and purchased from Integrated DNA Technologies (Supplementary Table 5). DNA templates were purified with AMPure XP beads (Beckman Coulter) following the manufacturer's instructions. RNA was then prepared by in vitro transcription from these DNA templates, then purified with Zymo RNA Clean and Concentrator columns (Zymo Research) following the manufacturer's instructions. Complete details of the RNA preparation, including preparation of the *Tetrahymena* ribozyme RNA, are provided in Supplementary Note 1.

After preparing the RNA, we confirmed that the three ribozymes in our benchmark set (*Tetrahymena* ribozyme, hc16 and 24-3) were catalytically active (Supplementary Fig. 5). We performed activity assays as previously described<sup>13,14</sup> with fluorescently labeled RNA substrates, and ran gels to check that the appropriate products were generated. Complete details are provided in Supplementary Note 2.

**Native gels.** All native gels were run using a BioRad Criterion Cell gel cassette. Polyacrylamide gels were cast by combining 15 ml of 8% or 12% 29:1 acrylamide/bis in 10 mM MgCl<sub>2</sub>, 67 mM HEPES, 33 mM Tris, pH 7.2 solution with 150 µl of 10% ammonium persulfate and 30 µl of TEMED. After the gel polymerized, chilled buffer containing 33 mM Tris, 10 mM MgCl<sub>2</sub> and 67 mM HEPES, pH 7.2, was added and the gel apparatus was placed in an ice bath in a 4 °C cold room. Folded RNA was prepared as follows: 1 µg of RNA was diluted to a volume of 6.4 µl, then incubated at 90 °C for 3 min, and then at room temperature for 10 min. Next, 0.8 µl of 500 mM Na-HEPES pH 8 and 0.8 µl of 100 mM MgCl<sub>2</sub> were added, and then the reaction was incubated at 50 °C for 20 min, and finally for 10 min at room temperature. All RNAs were screened in the apo state. Then, 2 µl of loading buffer containing 250 mM Na-HEPES pH 7.5, 5 mM EDTA pH 8, 50% glycerol, 0.05% xylene cyanol and 0.05% bromophenol blue was added and samples were loaded into the gel immediately. The gel was run at 10 W for 1.5 h. The temperature of the gel was monitored closely to avoid overheating. To visualize the RNA, the gel was submerged in Stains-All working solution (0.015% dye in 45% formamide) and placed on an orbital shaker for 25 min. The Stains-All solution was then removed and the gel was de-stained in water for 15 min. The water was then removed and the gel was imaged.

**M2-seq experiments.** M2-seq experiments were performed as previously described<sup>30</sup>. Complete details are provided in Supplementary Note 3.

**Cryo-EM sample preparation.** RNAs were prepared as follows. RNAs were combined with Na-HEPES, pH 8.0, and incubated at 90 °C for 3 min, then cooled at room temperature for 10 min. MgCl<sub>2</sub> and any ligands were added and the solution was incubated at 50 °C for 20 min (30 min for *Tetrahymena* ribozyme), then cooled at room temperature for 10 min. The final concentrations were 10 mM MgCl<sub>2</sub>, 50 mM Na-HEPES, pH 8.0. The final RNA and ligand concentrations were: 15 µM *Tetrahymena* ribozyme RNA; 15 µM hc16 product RNA; 15 µM hc16 RNA; 25 µM scaRNA6 RNA; 25 µM *V. cholerae* glycine riboswitch RNA and 100 mM glycine; 15 µM *V. cholerae* glycine riboswitch RNA; 21 µM RB1 5' UTR RNA; 25 µM U1 snRNA RNA; 25 µM 24-3 RNA; 13 µM *F. nucleatum* glycine riboswitch RNA and 100 mM glycine; 17 µM *F. nucleatum* glycine riboswitch RNA; 20 µM Eterna3D-JR\_1 RNA; 26 µM spinach-TTR-3 RNA; 27 µM ATP-TTR-3 RNA and 1 mM AMP; 30 µM ATP-TTR-3 RNA; 40 µM SAM-IV riboswitch RNA and 1 mM SAM; 45 µM SAM-IV riboswitch RNA; 40 µM downstream peptide riboswitch RNA; and 10 mM glutamine.

**Cryo-EM data collection.** First, 3 µl of the samples was applied onto glow-discharged 200-mesh R2/1 or R3.5/1 Quantifoil grids. The grids were blotted for 2–4 s and flash-frozen in liquid ethane using a Vitrobot Mark IV (Thermo Fisher Scientific) with the chamber cooled to 4 °C and at 100% humidity. The *Tetrahymena* ribozyme, hc16, hc16 product, RB1 5' UTR RNA, U1 snRNA RNA, *F. nucleatum* glycine riboswitch with and without glycine, Eterna3D-JR\_1 RNA, spinach-TTR-3 RNA, ATP-TTR-3 with and without AMP, and downstream peptide riboswitch with glutamine were imaged on a Talos Arctica cryo-electron microscope with a Volta phase plate. Between 600 and 1,414 micrographs were collected for each sample. The scaRNA6 and 24-3 RNAs were imaged on a Titan Krios cryo-electron microscope (Thermo Fisher Scientific) with GIF energy filter (Gatan), without a phase plate, and 860 and 2,260 micrographs were collected, respectively. Initial datasets of approximately 500 images (23,000 particles) for the apo SAM-IV riboswitch and 900 images (20,000 particles) for the apo *V. cholerae* glycine riboswitch were collected on a Talos Arctica cryo-electron microscope with a Volta phase plate and a JEOL ARM300 cryo-electron microscope with a hole-free phase plate, respectively. We performed 2D analysis as described in "Cryo-EM image processing" and confirmed that RNA helices could be identified in the 2D class averages before collecting additional data. We did not collect similar initial datasets for the SAM-IV riboswitch with SAM or for the *V. cholerae* glycine riboswitch with glycine because we assumed that the data quality would be similar with and without the ligands. We then collected larger datasets for the SAM-IV riboswitch with and without SAM and the *V. cholerae* glycine riboswitch with and

without glycine on a Titan Krios cryo-electron microscope with GIF energy filter, without a phase plate. All micrographs were recorded by EPU software (Thermo Fisher Scientific) with a Gatan K2 Summit direct electron detector, where each image was composed of 30 individual frames with an exposure time of 6 s. All images were collected with defocus between –0.5 and –3.5 µm.

**Cryo-EM image processing.** All micrographs were motion-corrected using MotionCor2 (ref. <sup>44</sup>) v.1.2.1 and the contrast transfer function was determined using CTFIND4 (ref. <sup>45</sup>) v.4.1.13. All particles were autopicked using the NeuralNet option in EMAN2 (ref. <sup>46</sup>) v.2.3, and further checked manually to select additional good particles that were missed and also to remove some bad particles. Then, particle coordinates were imported to Relion<sup>47</sup> v.3.0.2, where the 2D classification was performed. Several rounds of 2D classification were performed to remove poor 2D classes without clear RNA features. After 2D classification, we performed 3D reconstruction with cryoSPARC<sup>48</sup> v.2.0.20, Relion<sup>48</sup> v.3.0.2 and EMAN2 (ref. <sup>46</sup>) v.2.3. For each RNA, the software that produced the highest-resolution map was used to generate the final map. In summary, for the SAM-IV riboswitch with and without SAM, *V. cholerae* glycine riboswitch with and without glycine, RB1 5' UTR, U1 snRNA, Eterna3D-JR\_1, spinach-TTR-3, scaRNA6 and 24-3 ribozyme, we used cryoSPARC<sup>48</sup>, including 3D initial model building and classification with the 'Ab initio reconstruction' option, and 3D refinement using the 'homogeneous refinement' option. For the *Tetrahymena* ribozyme, hc16 ligase, hc16 ligase product, *F. nucleatum* glycine riboswitch with and without glycine, ATP-TTR-3 with and without AMP, and downstream peptide riboswitch with glutamine, we used EMAN2 to build the 3D initial model using 'e2initialmodel.py', then performed 3D classification and final 3D refinement in Relion. Additional information about the data collection and image processing, including the initial and final numbers of particles, can be found in Supplementary Table 1. A representative example of the data-processing workflow is shown for the apo state of the *V. cholerae* glycine riboswitch in Extended Data Fig. 3. Local map resolution was calculated with ResMap (Extended Data Fig. 5)<sup>49</sup>.

The auto-DRRAFTER pipeline is illustrated in Extended Data Fig. 6. The inputs to auto-DRRAFTER were an RNA sequence, secondary structure and cryo-EM map, and the output was a collection of 3D models of the RNA structure. The auto-DRRAFTER pipeline begins by representing both the map and secondary structure as graphs to enable automated placement of at least one RNA helix in the density map (Extended Data Fig. 6a–c). This process may result in multiple possible helix placements. For each of these, the rest of the RNA was then built with RNA fragment assembly in Rosetta, keeping the placed helix fixed throughout the run<sup>50</sup>. The low-resolution and all-atom Rosetta score functions were augmented with the elec\_dens\_fast score term to monitor agreement with the density map<sup>51</sup>.

Modeling was performed in several rounds (Extended Data Fig. 6c–j). For each round, 1,000 models (for the simulated benchmark) or 2,000 models (for the models built into experimental maps) were built for each placement. The average pairwise r.m.s.d. (convergence) was then computed for the top-ten-scoring models across all helix placements. If the convergence r.m.s.d. was higher than 10 Å, then another round of modeling was performed. Elements of the structure that had converged and fit well in the density map in the previous round of modeling were then kept fixed for the subsequent modeling round. When the convergence of the top-ten-scoring models across all possible helix placements dropped below 10 Å, two final rounds of modeling were performed in which the conformations of the converged regions were refined while poorly converged regions continued to be modeled de novo. The last modeling round was performed in parallel in separate half maps, if available. The total numbers of modeling rounds performed for all RNAs described here are listed in Supplementary Tables 2 and 6. One round of modeling took approximately 1 d on 50× (number of helix placements) cores (Intel Xeon E5-2640v4 processors). The complete details of the auto-DRRAFTER pipeline are described in Supplementary Note 4. Figures were prepared with Pymol and UCSF Chimera<sup>52</sup>.

**Auto-DRRAFTER benchmark on simulated maps.** Starting with the database of nonredundant RNA PDB structures (release 3.39) solved to 4.0 Å resolution or better<sup>53</sup>, we found all RNA structures of length between 100 and 450 nucleotides, then removed structures with protein or DNA residues, multiple chains and/or many missing residues. This yielded 25 structures, from which we selected a set of eight functionally and structurally diverse RNAs: THF riboswitch (PDB ID: 3SUX)<sup>54</sup>, c-di-AMP riboswitch (PDB ID: 4QK8)<sup>55</sup>, bacterial SRP Alu domain (PDB ID: 4WFL)<sup>56</sup>, FMN riboswitch (PDB ID: 3F2Q)<sup>57</sup>, SAM-I riboswitch (PDB ID: 4KQY)<sup>58</sup>, *Tetrahymena* ribozyme P4-P6 domain (PDB ID: 1GID)<sup>59</sup>, lysine riboswitch (PDB ID: 3DIL)<sup>60</sup> and the lariat capping ribozyme (PDB ID: 4P8Z)<sup>61</sup>. Density maps were simulated at 10 Å resolution with EMAN2 using the following command:

```
e2pdb2mrc.py crystal_structure.pdb simulated_map.mrc
--res=10.0 --center
```

We then built models with auto-DRRAFTER starting from the RNA sequences, secondary structures derived from the crystal structures and simulated

density maps. Fragments from homologous RNA structures were excluded during the fragment assembly stages of the auto-DRRAFTER runs with the following flags:

```
-fragment_homology_rmsd 1.2 -exclusion_match_type
MATCH_YR-exclude_fragment_files crystal_structure.pdb
```

where `crystal_structure.pdb` is the previously solved crystal structure. R.m.s.d. values between auto-DRRAFTER models and the crystal structure were calculated over all heavy atoms (all atoms except hydrogens) after alignment over all heavy atoms.

For the THF riboswitch, we also built models into the 2.9 Å crystallographic density map. Models were built as described for the simulated density map, but with the crystallographic density substituted for the simulated density map.

**HIV-1 DIS blind modeling challenge.** Models for the HIV-1 DIS dimer were built with multiple different strategies using an early version of auto-DRRAFTER that required manually placing at least one helix in the cryo-EM density map and in which all modeling was performed in a single round<sup>11</sup>. The complete details are provided in Supplementary Note 5.

**T-box-tRNA complex modeling.** Models of the *B. subtilis* T-box-tRNA complex were built into a 4.9 Å cryo-EM map using auto-DRRAFTER. Three helices were initially fit into the density map (tRNA residues 1–7, 65–71, 38–42, 26–30 and 33–35, and T-box residues 99–101). These initial placements were automatically optimized throughout the modeling process. Five rounds of auto-DRRAFTER modeling were performed. R.m.s.d. accuracies were calculated by comparing with the published model, which was based on high-resolution crystal structures<sup>31</sup>.

**Fully automated and ‘best-case’ models for experimental density maps.** Automated models were built for all experimental density maps using the auto-DRRAFTER method with secondary structures derived from our M2-seq experiments. Additionally, we built a set of best-case auto-DRRAFTER models for these same systems that integrated additional information with the cryo-EM and M2-seq data to generate models of potentially higher accuracy. For this set of models, the M2-seq-based secondary structures were modified based on sequence covariation information and previously solved crystal structures (Extended Data Fig. 8). Additionally, specific elements of the RNA structures were initially placed in the density maps rather than using the automatic helix placement strategy described in Supplementary Note 4. These elements were allowed to move from their initial positions during all rounds of modeling. A complete description of this modeling is provided in Supplementary Note 6.

**Auto-DRRAFTER error estimates and model validation.** To estimate model error, we calculated the auto-DRRAFTER modeling convergence, defined as the average pairwise r.m.s.d. over the top-ten-scoring auto-DRRAFTER models. Models were not aligned before computing r.m.s.d. values. All r.m.s.d. values reported in this work are computed over all atoms except hydrogens. For models built into half maps, the convergence was defined as the average pairwise r.m.s.d. between the top-ten-scoring models refined into each of the half maps. For models built into a single map, convergence can be calculated in Rosetta with the following command:

```
drrafter_error_estimation -s <models> -rmsd_nosuper
```

For models built into separate half maps, convergence can be calculated with the following command:

```
drrafter_error_estimation -sgroup1<models1>
-sgroup2<models2> -rmsd_nosuper
```

where `models1` and `models2` are the top-ten-scoring models refined into the two separate half maps.

Modeling convergence correlates with model accuracy ( $r^2=0.95$  for the benchmark on simulated maps, two-tailed  $P=9\times 10^{-29}$ ,  $N=45$ ), with a best-fit line of  $y=0.61x+2.4$  Å. This linear relationship was used to predict model accuracy for all models built into experimental density maps. Per-residue convergence was similarly calculated over the top-ten-scoring models and also correlates with per-residue model accuracy ( $r^2=0.88$  for the benchmark on simulated maps, two-tailed  $P<0.001$ ,  $N=6,357$ ), with a best-fit line of  $y=0.75x+2.0$  Å. Real-space correlation coefficients over the full model and per residue were calculated in Rosetta with the following command<sup>42</sup>:

```
density_tools -s <model> -mapfile <density map>
-mapreso <map resolution> -cryo-EM_scatterers
-denstools::perres
```

R.m.s.d. accuracies relative to higher-resolution coordinates were computed over all heavy atoms. Mean r.m.s.d. values were calculated as the mean of the r.m.s.d. values of each of the top-ten-scoring Ribosome models built into separate half maps, if available, relative to the higher-resolution coordinates.

**Statistics.** All cryo-EM statistics are reported in Supplementary Table 1. Auto-DRRAFTER modeling statistics are reported in Supplementary Tables 2, 3 and 6. We used auto-DRRAFTER to build 2,000 models per round for each RNA for which we had an experimental density map, and 1,000 models per round for simulated density maps. The numbers of rounds of modeling are provided in Supplementary Tables 2, 3 and 6. Pearson's correlation coefficients ( $r^2$ ) are reported with the exact  $N$  values used for calculations. All  $P$  values reported are two-tailed.

**hc16 mutate-map-rescue experiments.** All mutate-map-rescue experiments were performed as previously described on the hc16 product construct used for the M2-seq experiments<sup>40</sup>. Details are provided in Supplementary Note 7.

**Reporting Summary.** Further information on research design is available in the Nature Research Reporting Summary linked to this article.

## Data availability

Cryo-EM maps are available in the EMDB with accession codes EMD-21831, EMD-21832, EMD-21833, EMD-21834, EMD-21835, EMD-21836, EMD-21838, EMD-21839, EMD-21840, EMD-21841 and EMD-21842. Models (best-case) are available in the PDB with accession codes 6WLJ, 6WLK, 6WLL, 6WLM, 6WLN, 6WLO, 6WLQ, 6WLR, 6WLS, 6WLT and 6WLU. Fully automated models are available in the Supplementary Data. M2-seq and mutate-map-rescue data are available in the RMDB with accession codes RB1UTR\_DMS\_0000, 243RNA\_DMS\_0000, ATPAPO\_DMS\_0000, ATPAMP\_DMS\_0000, UISNRNA\_DMS\_0000, SCARNA6\_DMS\_0000, VCKTAPO\_DMS\_0000, VCKTGLY\_DMS\_0000, DPRGLN\_DMS\_0000, ETERNA3\_DMS\_0000, SPINACH\_DMS\_0000, FNKTAPO\_DMS\_0000, FNKTGLY\_DMS\_0000, HC16APO\_DMS\_0000, HC16PRO\_DMS\_0000, SAM4APO\_DMS\_0000, SAM4SAM\_DMS\_0000, L21RNA\_DMS\_0000, HC16M2R\_1M7\_0001, HC16M2R\_1M7\_0002 and HC16M2R\_1M7\_0003. The raw particle image data that support the findings of this study are available from the corresponding author upon request.

## Code availability

The auto-DRRAFTER software is freely available to academic users as part of the Rosetta software package. Documentation is available at [https://www.rosettacommons.org/docs/latest/application\\_documentation/rna/auto-drrafter](https://www.rosettacommons.org/docs/latest/application_documentation/rna/auto-drrafter) and a demo is available at <https://www.rosettacommons.org/demos/latest/public/auto-drrafter/README>. A limited version of the software is also freely available through an online ROSIE server at <https://rosie.rosettacommons.org/auto-drrafter>.

## References

- Tian, S., Yesselman, J. D., Cordero, P. & Das, R. Primerize: automated primer assembly for transcribing non-coding RNA domains. *Nucleic Acids Res.* **43**, W522–W526 (2015).
- Zheng, S. Q. et al. MotionCor2: anisotropic correction of beam-induced motion for improved cryo-electron microscopy. *Nat. Methods* **14**, 331–332 (2017).
- Rhou, A. & Grigorieff, N. CTFFIND4: fast and accurate defocus estimation from electron micrographs. *J. Struct. Biol.* **192**, 216–221 (2015).
- Tang, G. et al. EMAN2: an extensible image processing suite for electron microscopy. *J. Struct. Biol.* **157**, 38–46 (2007).
- Scheres, S. H. W. RELION: implementation of a Bayesian approach to cryo-EM structure determination. *J. Struct. Biol.* **180**, 519–530 (2012).
- Punjani, A., Rubinstein, J. L., Fleet, D. J. & Brubaker, M. A. cryoSPARC: algorithms for rapid unsupervised cryo-EM structure determination. *Nat. Methods* **14**, 290 (2017).
- Kucukelbir, A., Sigworth, F. J. & Tagare, H. D. Quantifying the local resolution of cryo-EM density maps. *Nat. Methods* **11**, 63–65 (2014).
- Das, R., Karanicolas, J. & Baker, D. Atomic accuracy in predicting and designing noncanonical RNA structure. *Nat. Methods* **7**, 291–294 (2010).
- DiMaio, F. & Chiu, W. Tools for model building and optimization into near-atomic resolution electron cryo-microscopy density maps. *Methods Enzymol.* **579**, 255–276 (2016).
- Pettersen, E. F. et al. UCSF chimera—a visualization system for exploratory research and analysis. *J. Comput. Chem.* **25**, 1605–1612 (2004).
- Leontis, N. B. & Zirbel, C. L. Nonredundant 3D Structure Datasets for RNA Knowledge Extraction and Benchmarking. In *RNA 3D Structure Analysis and Prediction* (eds Leontis, N. & Westhof, E.) 281–298 (Springer, 2012).
- Huang, L., Ishibe-Murakami, S., Patel, D. J. & Serganov, A. Long-range pseudoknot interactions dictate the regulatory response in the tetrahydrofolate riboswitch. *Proc. Natl Acad. Sci. USA* **108**, 14801–14806 (2011).
- Gao, A. & Serganov, A. Structural insights into recognition of c-di-AMP by the ydaO riboswitch. *Nat. Chem. Biol.* **10**, 787–792 (2014).
- Kempf, G., Wild, K. & Sinning, I. Structure of the complete bacterial SRP Alu domain. *Nucleic Acids Res.* **42**, 12284–12294 (2014).
- Serganov, A., Huang, L. L. & Patel, D. J. Coenzyme recognition and gene regulation by a flavin mononucleotide riboswitch. *Nature* **458**, 233–U210 (2009).

58. Lu, C. R. et al. SAM recognition and conformational switching mechanism in the *Bacillus subtilis* yitJ S Box/SAM-I riboswitch. *J. Mol. Biol.* **404**, 803–818 (2010).
59. Cate, J. H. et al. Crystal structure of a group I ribozyme domain: principles of RNA packing. *Science* **273**, 1678–1685 (1996).
60. Serganov, A., Huang, L. L. & Patel, D. J. Structural insights into amino acid binding and gene control by a lysine riboswitch. *Nature* **455**, 1263–U1276 (2008).
61. Meyer, M. et al. Speciation of a group I intron into a lariat capping ribozyme. *Proc. Natl Acad. Sci. USA* **111**, 7659–7664 (2014).
62. Wang, R. Y. R. et al. Automated structure refinement of macromolecular assemblies from cryo-EM maps using Rosetta. *eLife* **5**, e17219 (2016).

## Acknowledgements

We thank members of the Das laboratory for useful discussions; members of the Rosetta community for discussions and code sharing; M. Summers for permission to perform the HIV-1 DIS blind modeling challenge; V. Kosaraju and J. Nicol for helping to develop the Eterna3D interface; and Eterna participant J.R. for designing the eterna3D-JR\_1 construct through the Eterna3D interface. Calculations were performed on the Stanford Sherlock cluster. Molecular graphics and analyses were performed with UCSF Chimera, developed by the Resource for Biocomputing, Visualization, and Informatics at the University of California, San Francisco, with support from NIH grant no. P41-GM103311. This work was supported by a Gabilan Stanford Graduate Fellowship (K.K.), the National Science Foundation (GRFP to K.K. and R.R.) and the National Institutes of Health (grant nos. P41GM103832, R01GM079429, P01AI120943, U54GM103297 and S10 OD021600 to W.C.; grant nos. R35 GM112579 and R21 AI145647 to R.D.).

## Author contributions

K.K., R.D. and W.C. conceptualized and designed the research. K.K. prepared the RNA samples for cryo-EM. K.Z., Z.S., S.L. and G.P. collected and analyzed the cryo-EM data. K.K. and V.V.T. collected and analyzed the M2-seq data. W.K. collected the mutate-map-rescue data. W.K. and K.K. analyzed the mutate-map-rescue data. K.K. developed, implemented and tested the computational approach with input from R.R., A.M.W. and R.D. K.K., A.M.W. and R.D. performed the blind DIS modeling. K.K. performed modeling for all other RNA systems. I.N.Z. prepared the 24-3 ribozyme RNA for cryo-EM and performed functional validation. J.D.Y. developed Eterna3D. A.M.W. developed the auto-DRRAFTER webserver. K.K. and R.D. wrote the manuscript with input from all authors.

## Competing interests

The authors declare no competing interests.

## Additional information

**Extended data** is available for this paper at <https://doi.org/10.1038/s41592-020-0878-9>.

**Supplementary information** is available for this paper at <https://doi.org/10.1038/s41592-020-0878-9>.

**Correspondence and requests for materials** should be addressed to W.C. or R.D.

**Peer review information** Arunima Singh and Allison Doerr were the primary editors on this article and managed its editorial process and peer review in collaboration with the rest of the editorial team.

**Reprints and permissions information** is available at [www.nature.com/reprints](http://www.nature.com/reprints).

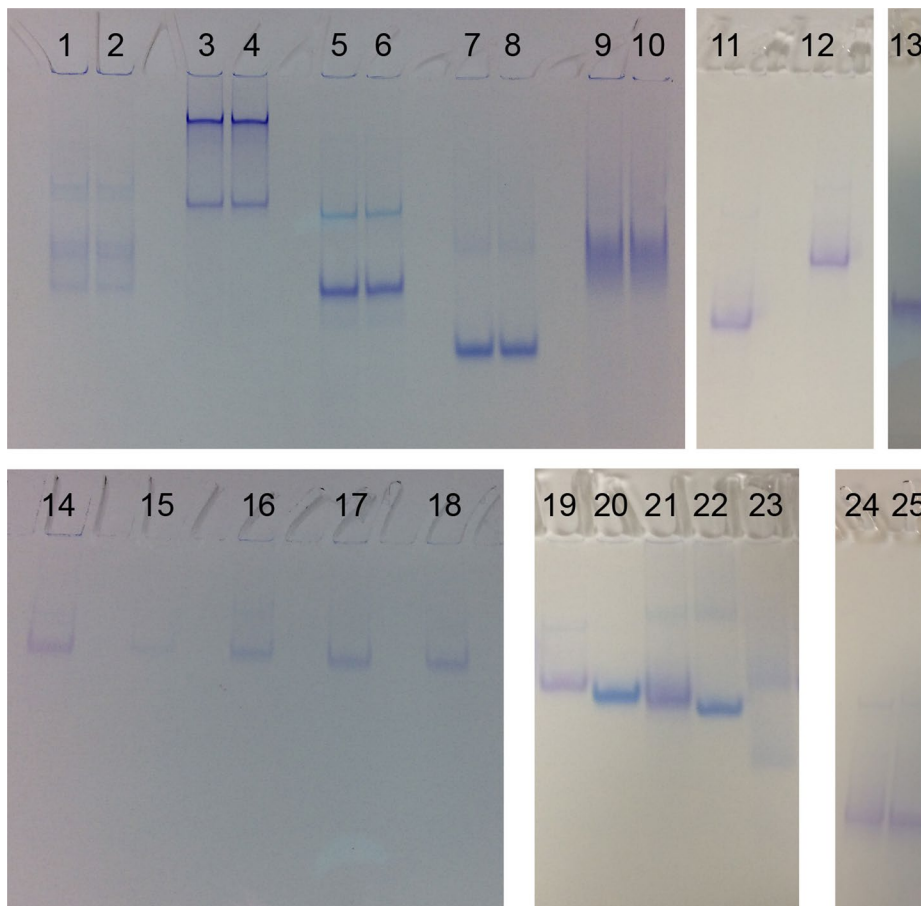

**Extended Data Fig. 1 | Native gel screens for all RNAs in this study.** Gel images for (1) and (2) RB1 5' UTR, (3) and (4) scaRNA6, (5) and (6) U1 snRNA, (7) and (8) SAM-IV riboswitch (apo), (9) and (10) 24-3, (11) *V. cholerae* glycine riboswitch (apo), (12) hc16, (13) *Tetrahymena* ribozyme, (14) *F. nucleatum* glycine riboswitch (apo), (15) and (16) Eterna3D-JR\_1, (17) and (18) spinach-TTR-3, (19) *F. nucleatum* glycine riboswitch (apo), (20) ATP-TTR-3 (apo), (21) Eterna3D-JR\_1, (22) SAM-IV riboswitch (apo), (23) downstream peptide riboswitch, (24) hc16, and (25) hc16 product. Samples 1-13, 24, 25 were run on an 8% polyacrylamide gel. Samples 14-23 were run on a 12% polyacrylamide gel. All samples were run in 10 mM MgCl<sub>2</sub>, 67 mM HEPES, 33 mM Tris, pH 7.2. All gels that were run are shown here (experiments were not repeated beyond results shown here).

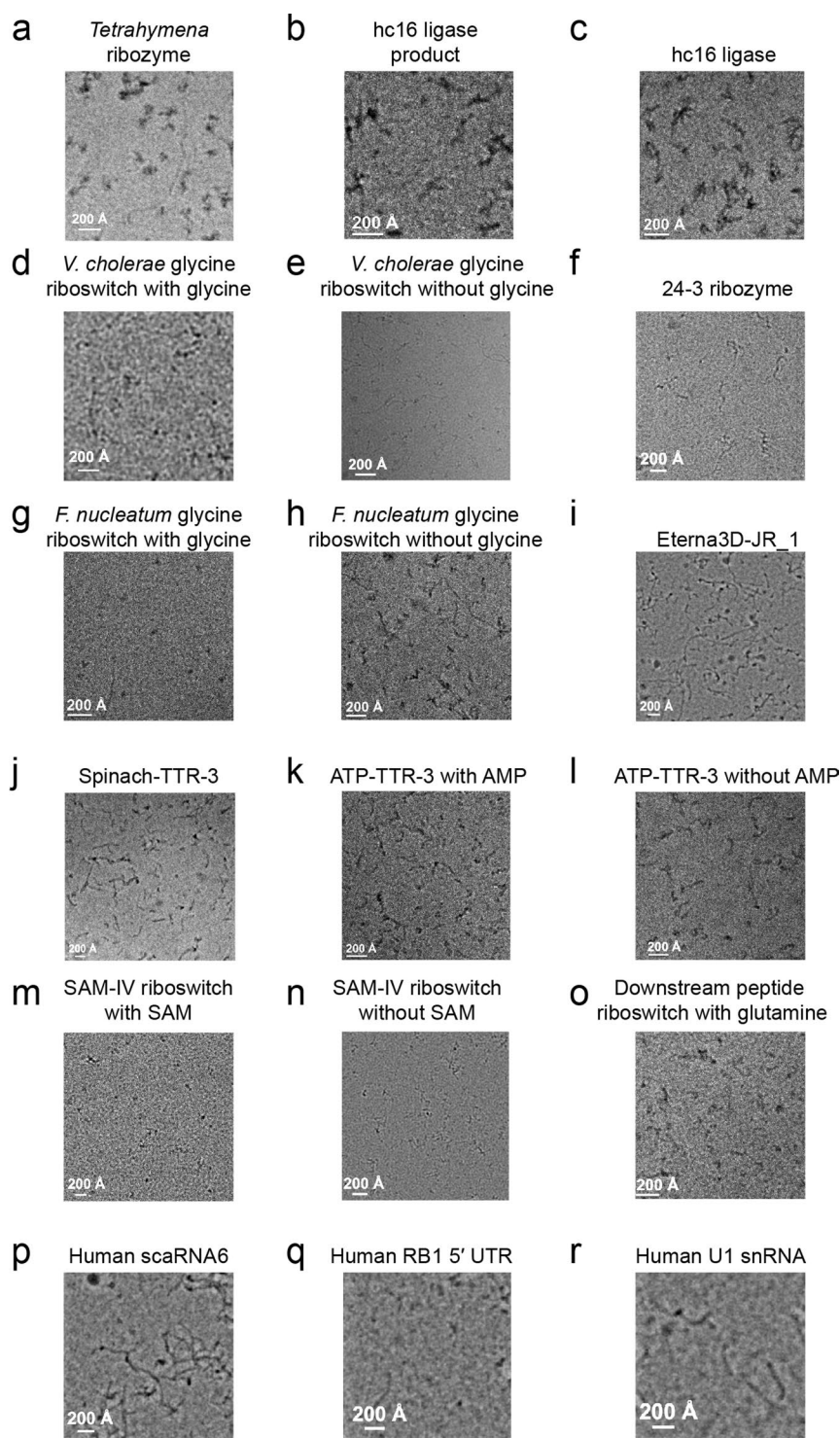

**Extended Data Fig. 2 | Representative micrographs for all RNAs in this study.** Micrographs shown in (a), (b), (c), (g), (h), (i), (j), (k), (l), (o), (q), and (r) were taken with the Talos Arctica. All others were taken with the Titan Krios. A Volta phase plate was used for (a), (b), (c), (g), (h), (i), (j), (k), (l), (o), and (q). The total numbers of micrographs collected are listed in Supplementary Table 1.

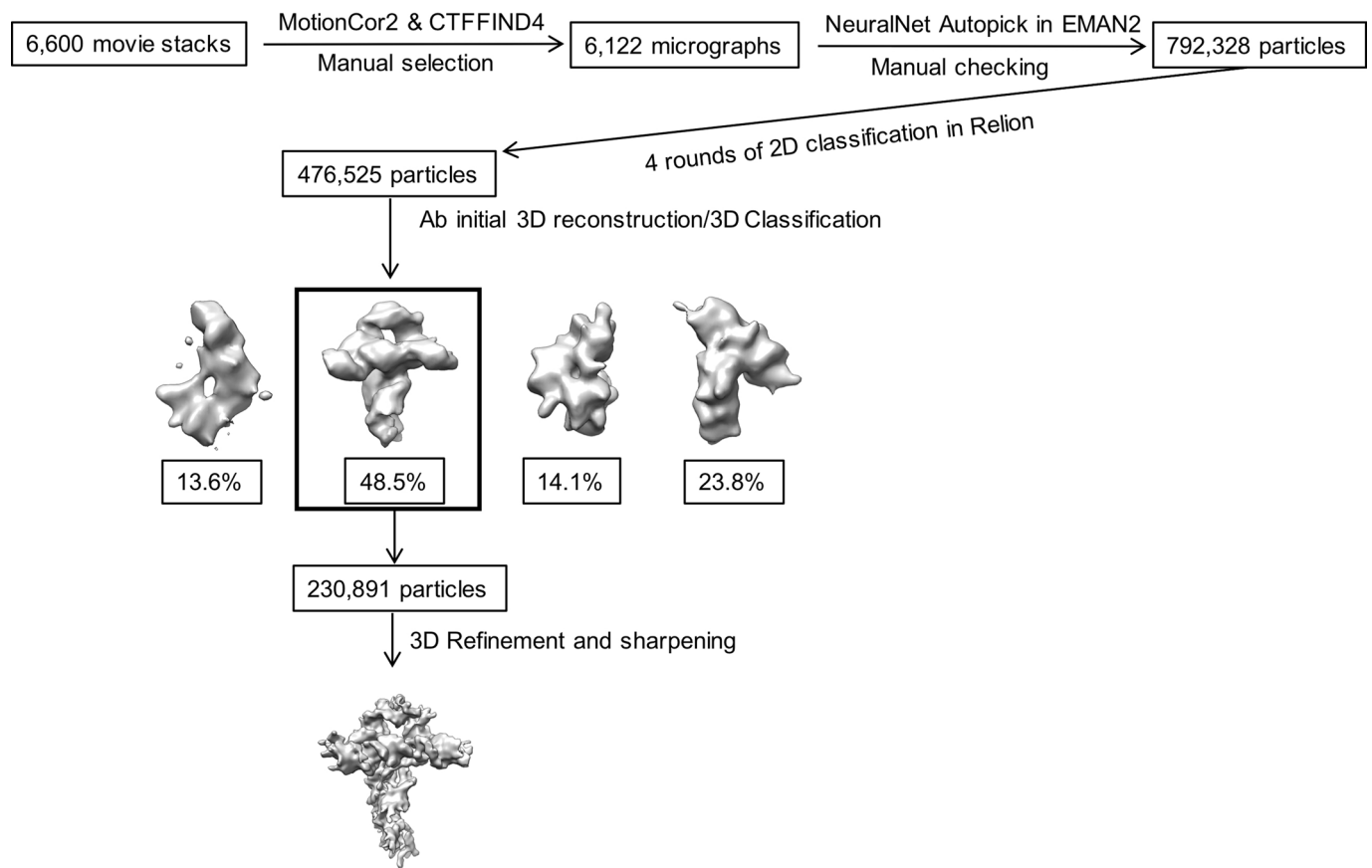

**Extended Data Fig. 3 | Example cryo-EM data processing workflow.** Shown here for the *V. cholerae* glycine riboswitch without glycine.

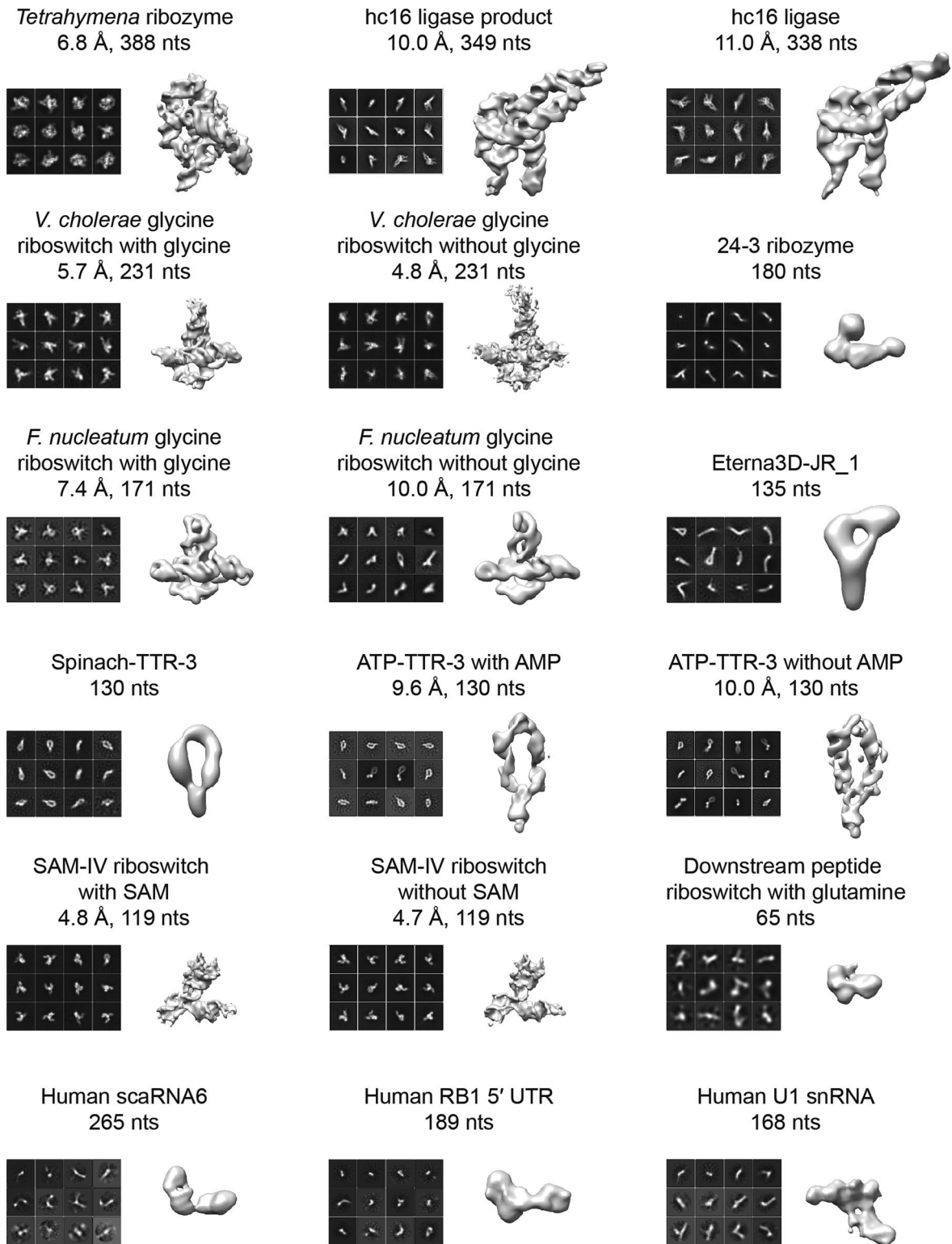

**Extended Data Fig. 4 | Cryo-EM 2D class averages and 3D reconstructions for all RNA systems in this study.** One dataset was collected for all RNAs except for the SAM-IV riboswitch without SAM and *V. cholerae* glycine riboswitch without glycine, for which smaller preliminary datasets were initially collected (see Methods). Results from these preliminary datasets were similar, though map resolution was lower. The numbers of particles used for the 3D reconstructions are listed in Supplementary Table 1.



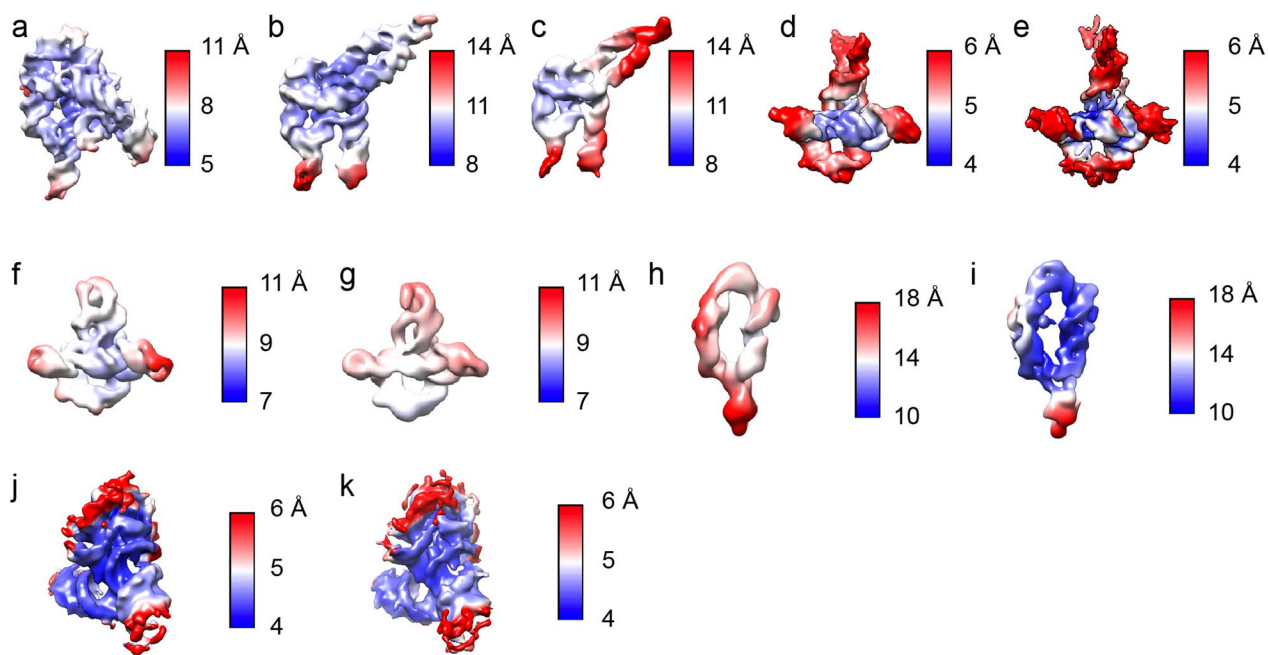

**Extended Data Fig. 5 | Local cryo-EM map resolution for RNA-only structures.** Calculated with ResMap<sup>48</sup> for (a) *Tetrahymena* ribozyme, (b) hc16 product, (c) hc16, (d) *V. cholerae* glycine riboswitch with glycine, (e) *V. cholerae* glycine riboswitch without glycine, (f) *F. nucleatum* glycine riboswitch with glycine, (g) *F. nucleatum* glycine riboswitch without glycine, (h) ATP-TTR-3 with AMP, (i) ATP-TTR-3 without AMP, (j) SAM-IV riboswitch with SAM, and (k) SAM-IV riboswitch without SAM.

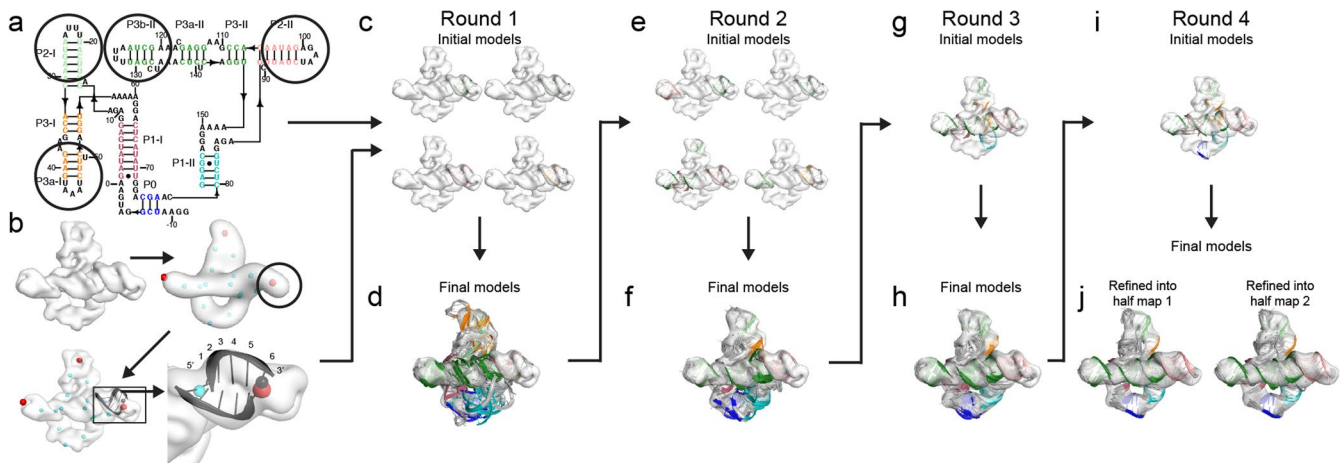

**Extended Data Fig. 6 | auto-DRRAFTER overview.** The *F. nucleatum* glycine riboswitch is shown here as an example. **a**, Secondary structure elements that connect to just one other helix or junction ('end nodes') are circled. **b**, The cryo-EM density map is low-pass filtered to 20 Å and points are placed (spheres) throughout the map to identify possible placements for 'end nodes' in the map (red spheres). The circled end node was randomly selected for initial helix placement. A probe helix (black) was then fit into the density map. The location of the probe helix was optimized, while the distances between the C1' atom of nucleotide 6 (nucleotides 1-6 labeled) of the probe helix (black sphere) and the end node and the neighboring map node were monitored (see Supplementary Note 4). **c**, 3D models are built for each of the elements circled in **(a)** and fit into the density map in the location of the circled point in **(b)**. These elements are kept fixed while the rest of the RNA is built into the density map. **d**, The top ten best scoring models after round 1. The overall convergence of these models is above the 10 Å threshold (convergence = 20.2 Å), so another round of modeling is performed. **e**, For the second round of modeling, regions that have converged are extracted from the top scoring models and kept fixed while the rest of the RNA is built into the density map. **f**, The top ten scoring models after round 2. The convergence is below the 10 Å threshold (convergence = 6.2 Å), so there is only one initial model for the third round of modeling, composed of converged regions from the top ten scoring models from round 2 **g**. These regions are allowed to move from their initial positions during this modeling round. **h**, The best scoring models from round 3. **i**, Again, converged regions are extracted from top scoring models to form the initial model for the final round of modeling. These regions are kept fixed during the fragment assembly stage of auto-DRRAFTER modeling, but allowed to move during final refinement. **j**, The top ten scoring models built independently into each half map. Helical regions are depicted with bright colors in **(c)-(j)** and match colors in the secondary structure diagram (A). Non-helical regions are colored gray.

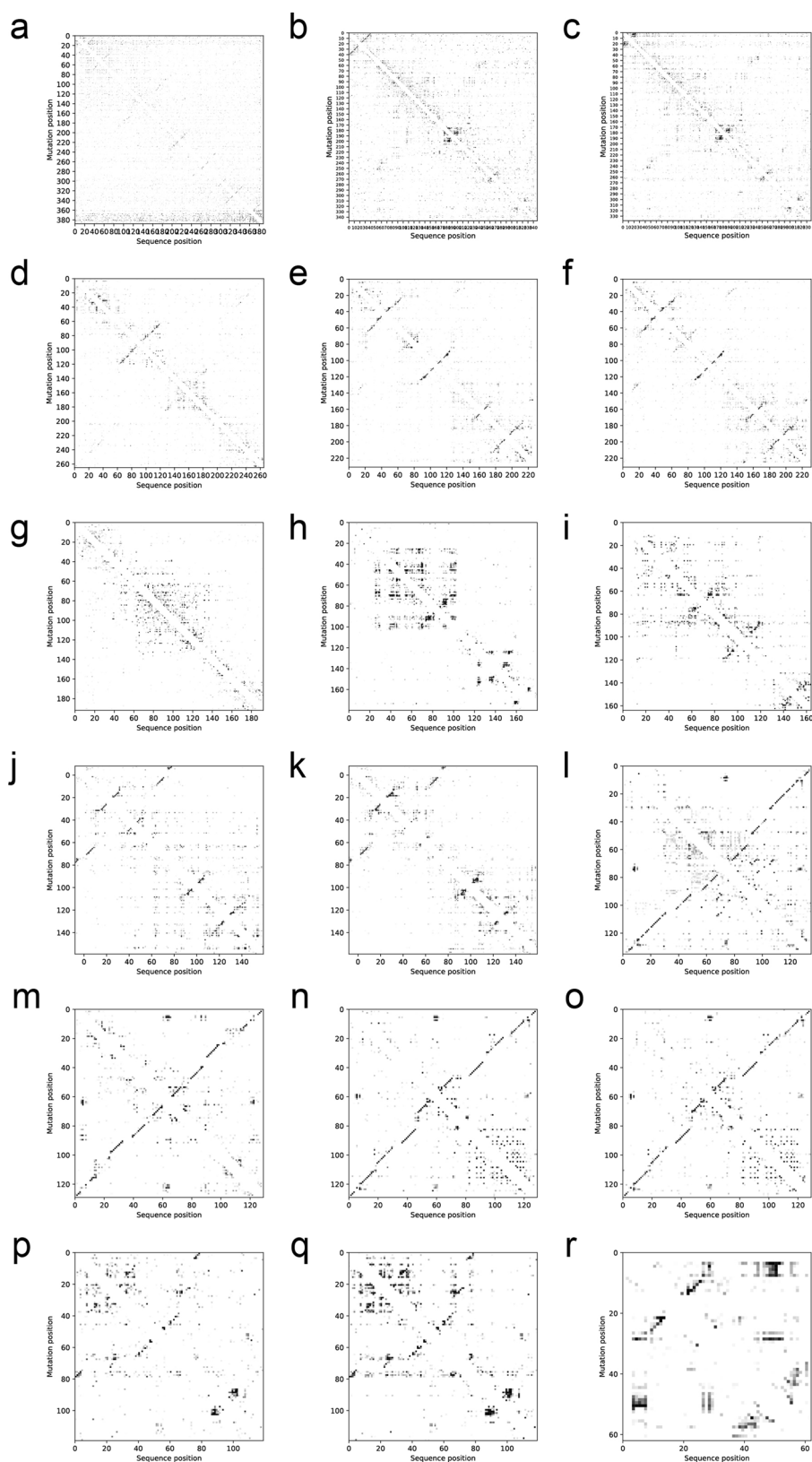

**Extended Data Fig. 7 | Experimental M2-seq z-score plots.** (a) *Tetrahymena* ribozyme (n = 65041 sequences), (b) hc16 product (n = 459852 sequences), (c) hc16 (n = 451568 sequences), (d) human scaRNA6 (n = 866158 sequences), (e) *V. cholerae* glycine riboswitch with glycine (n = 928767 sequences), (f) *V. cholerae* glycine riboswitch without glycine (n = 974343 sequences), (g) human RB1 5' UTR (n = 889700 sequences), (h) 24-3 (n = 515486 sequences), (i) human U1 snRNA (n = 1185187), (j) *F. nucleatum* glycine riboswitch with glycine (n = 803254 sequences), (k) *F. nucleatum* glycine riboswitch without glycine (n = 670301 sequences), (l) eterna3D-JR\_1 (n = 994048 sequences), (m) spinach-TTR-3 (n = 1090666 sequences), (n) ATP-TTR-3 with AMP (n = 914892 sequences), (o) ATP-TTR-3 without AMP (n = 712801 sequences), (p) SAM IV riboswitch with SAM (n = 131464 sequences), (q) SAM IV riboswitch without SAM (n = 991972 sequences), and (r) downstream peptide riboswitch (n = 1012081 sequences).

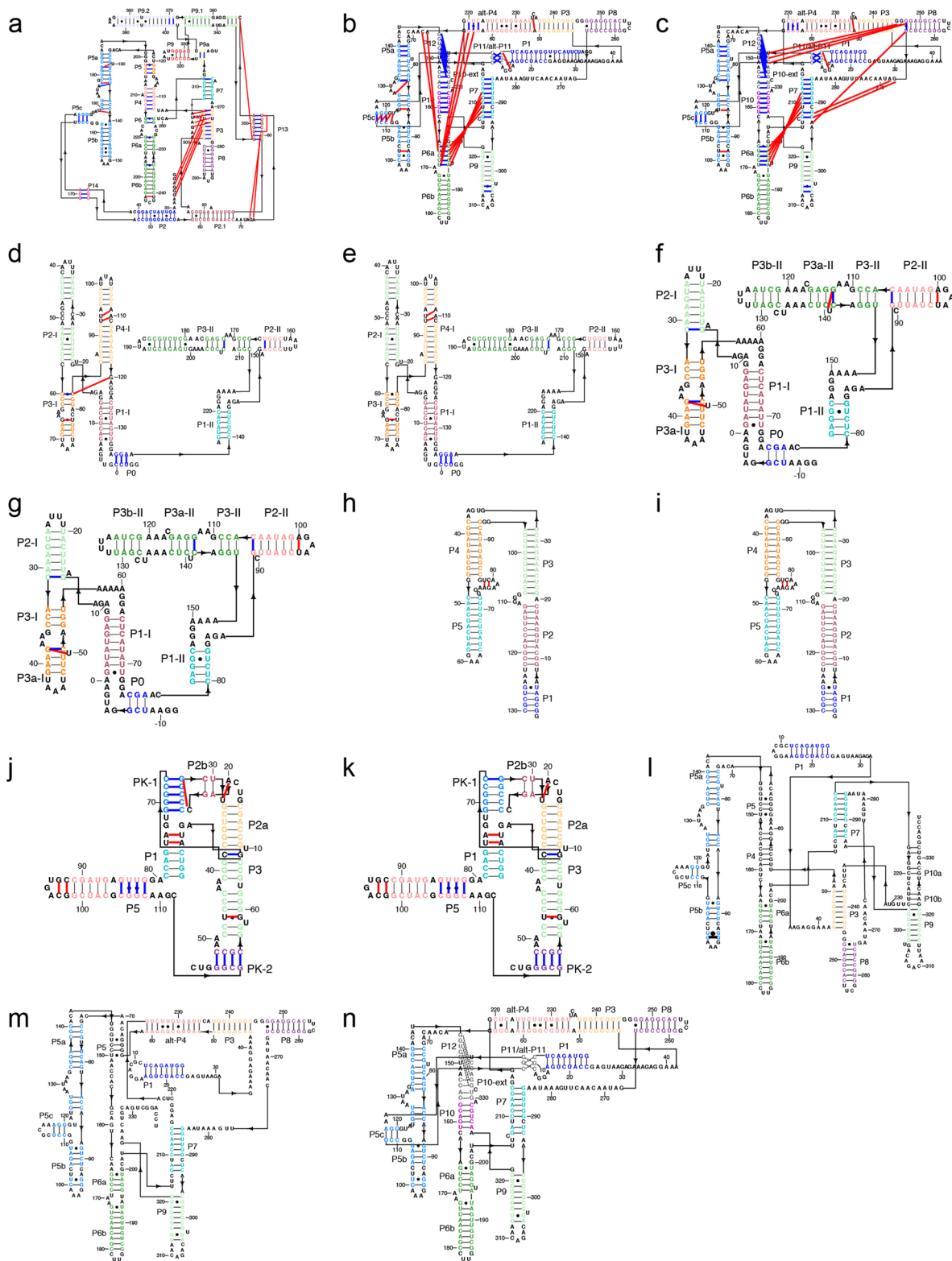

**Extended Data Fig. 8 | Secondary structures automatically derived from M2-seq data and revisions for best-case auto-DRRAFTER modeling based on sequence covariation and previously solved crystal structures. (a) *Tetrahymena* ribozyme, (b) hc16 product, (c) hc16, (d) *V. cholerae* glycine riboswitch with glycine, (e) *V. cholerae* glycine riboswitch without glycine, (f) *F. nucleatum* glycine riboswitch with glycine, (g) *F. nucleatum* glycine riboswitch without glycine, (h) ATP-TTR-3 with AMP (i) ATP-TTR-3 without AMP, (j) SAM-IV riboswitch with SAM, and (k) SAM-IV riboswitch without SAM. (a-k) Blue lines indicate base pairs that are present in the best-case, but not automated secondary structures. Red lines indicate base pairs that are present in the automated, but not best-case secondary structures. (l) The previously proposed hc16 secondary structure<sup>4</sup>. (m) M2-seq and mutate-map-rescue experiments suggest that hc16 contains alt-P4 rather than P4. (n) Additional modeling and experiments suggest further modifications to the hc16 secondary structure: alt-P4 is extended, a pseudoknot is formed between the hairpin loops of P5c and P1, P5 is not formed, and P10 is formed. Helical regions are depicted with bright colors that match those shown in Fig. 3. Non-helical regions are colored black.**

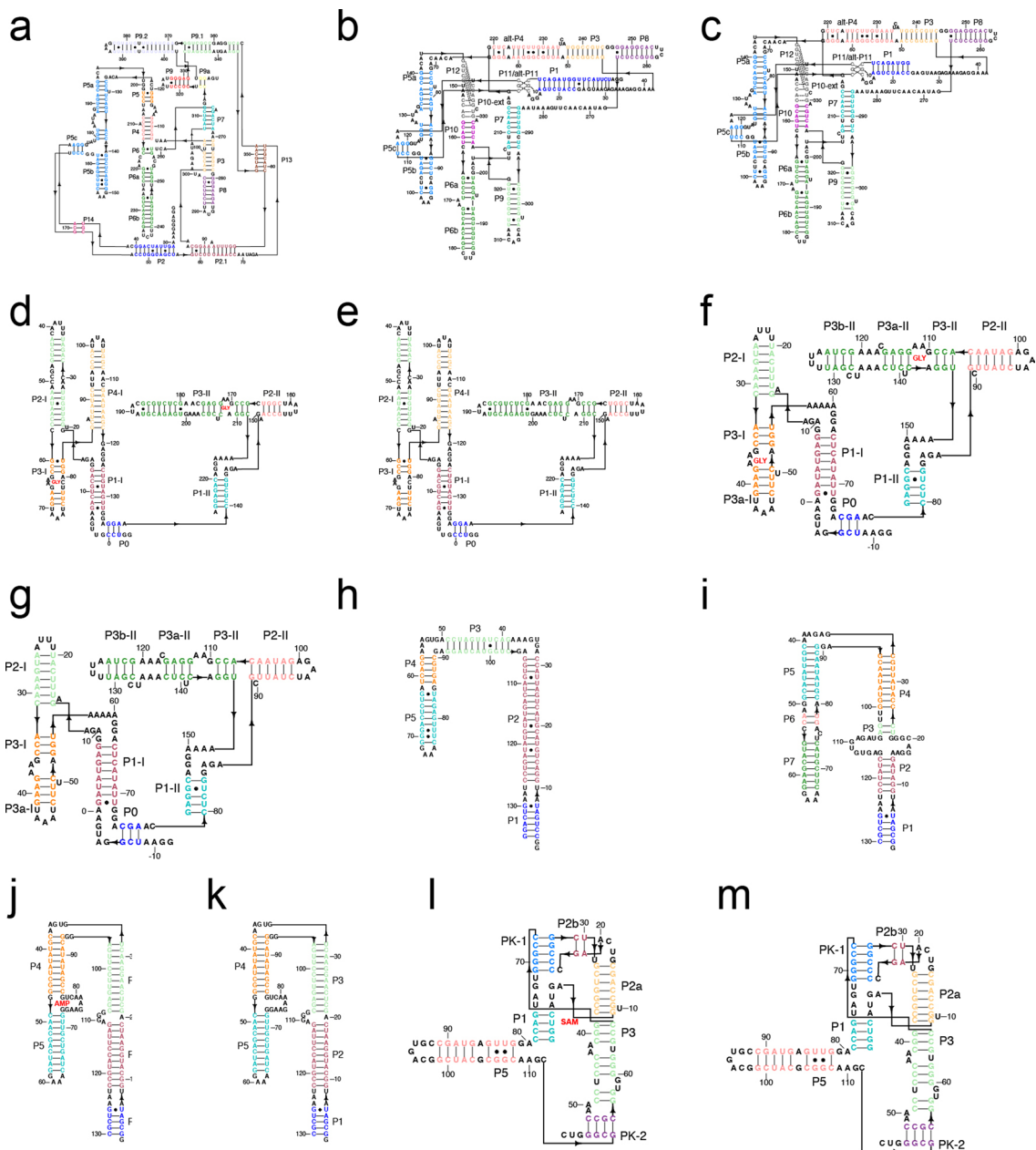

**Extended Data Fig. 9 | Secondary structures for best-case Ribosolve models. (a)** *Tetrahymena* ribozyme, **(b)** hc16 product, **(c)** hc16, **(d)** *V. cholerae* glycine riboswitch with glycine, **(e)** *V. cholerae* glycine riboswitch without glycine, **(f)** *F. nucleatum* glycine riboswitch with glycine, **(g)** *F. nucleatum* glycine riboswitch without glycine, **(h)** eterna3D-JR\_1 (see Fig. 6), **(i)** spinach-TTR-3 (discussed in ‘Limitations of the Ribosolve pipeline’ in the main text), **(j)** ATP-TTR-3 with AMP **(k)** ATP-TTR-3 without AMP, **(l)** SAM-IV riboswitch with SAM, and **(m)** SAM-IV riboswitch without SAM. Helical regions are depicted with bright colors that match those shown in Fig. 3. Non-helical regions are colored black.

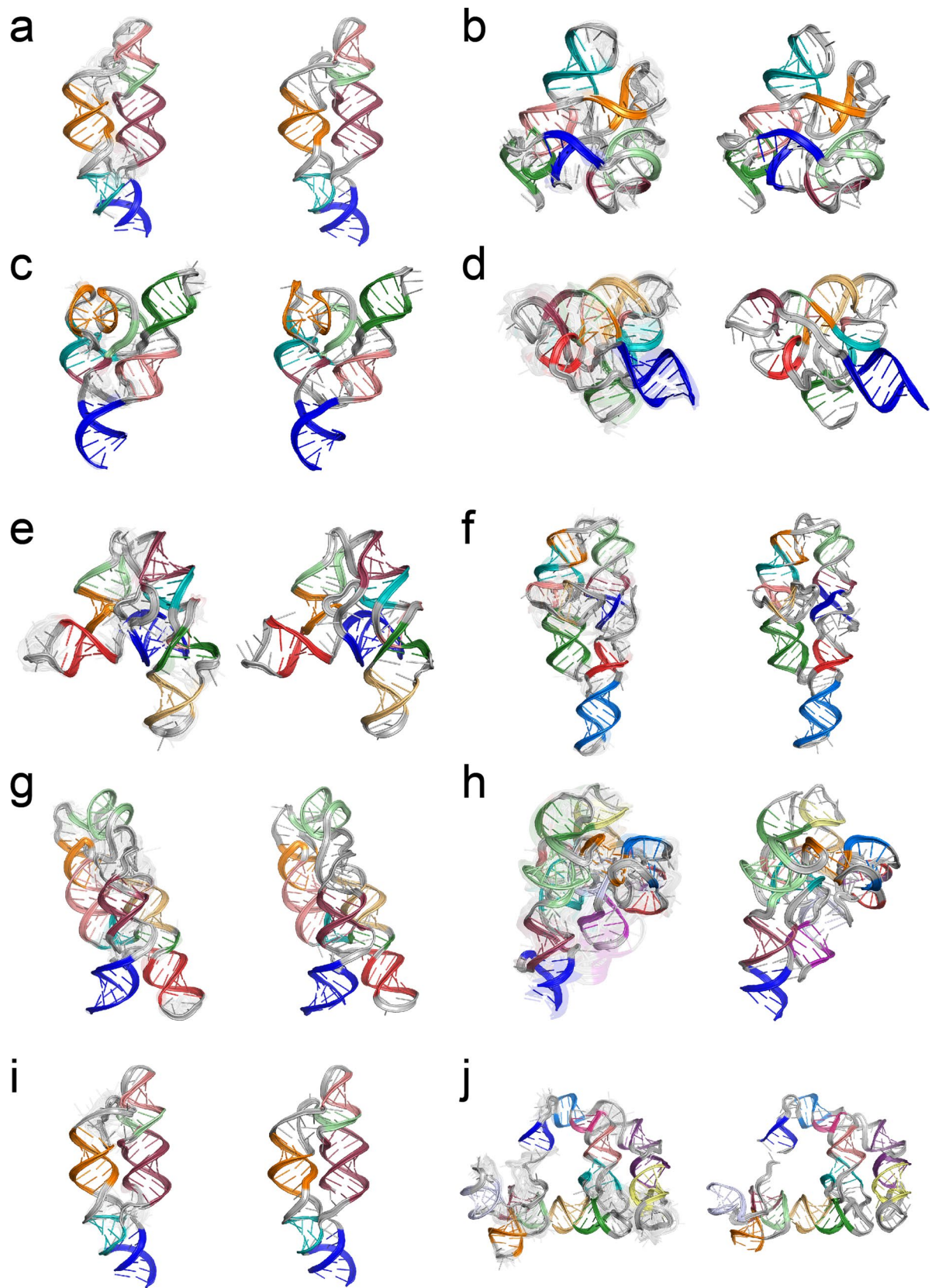

**Extended Data Fig. 10 | Benchmarking auto-DRRAFTER accuracy.** (a–h) The top ten scoring auto-DRRAFTER models (models #2–10 are transparent) built into 10 Å simulated density maps (left) and the corresponding crystal structures (right) for (a) THF riboswitch, (b) c-di-AMP riboswitch, (c) bacterial SRP Alu domain, (d) FMN riboswitch, (e) SAM-I riboswitch, (f) *Tetrahymena* ribozyme P4-P6 domain, (g) lysine riboswitch, and (h) lariat capping ribozyme. (i) Ribosolve models for THF riboswitch built into the previously solved 2.9 Å crystallographic density map (left) and the crystal structure (right). (j) Ribosolve models for the *B. subtilis* T-box-tRNA complex built into a 4.9 Å cryo-EM map (left) and previously modeled coordinates (right) based on high-resolution crystal structures<sup>30</sup>. Helical regions are depicted with bright colors. Non-helical regions are colored gray.

## Reporting Summary

Nature Research wishes to improve the reproducibility of the work that we publish. This form provides structure for consistency and transparency in reporting. For further information on Nature Research policies, see [Authors & Referees](#) and the [Editorial Policy Checklist](#).

### Statistics

For all statistical analyses, confirm that the following items are present in the figure legend, table legend, main text, or Methods section.

n/a Confirmed

- The exact sample size ( $n$ ) for each experimental group/condition, given as a discrete number and unit of measurement
- A statement on whether measurements were taken from distinct samples or whether the same sample was measured repeatedly
- The statistical test(s) used AND whether they are one- or two-sided  
*Only common tests should be described solely by name; describe more complex techniques in the Methods section.*
- A description of all covariates tested
- A description of any assumptions or corrections, such as tests of normality and adjustment for multiple comparisons
- A full description of the statistical parameters including central tendency (e.g. means) or other basic estimates (e.g. regression coefficient) AND variation (e.g. standard deviation) or associated estimates of uncertainty (e.g. confidence intervals)
- For null hypothesis testing, the test statistic (e.g.  $F$ ,  $t$ ,  $r$ ) with confidence intervals, effect sizes, degrees of freedom and  $P$  value noted  
*Give  $P$  values as exact values whenever suitable.*
- For Bayesian analysis, information on the choice of priors and Markov chain Monte Carlo settings
- For hierarchical and complex designs, identification of the appropriate level for tests and full reporting of outcomes
- Estimates of effect sizes (e.g. Cohen's  $d$ , Pearson's  $r$ ), indicating how they were calculated

*Our web collection on [statistics for biologists](#) contains articles on many of the points above.*

### Software and code

Policy information about [availability of computer code](#)

#### Data collection

The auto-DRRAFTER software is freely available to academic users as part of the Rosetta software suite at [www.rosettacommons.org](http://www.rosettacommons.org). Documentation is available at [https://www.rosettacommons.org/docs/latest/application\\_documentation/rna/auto-drrafter](https://www.rosettacommons.org/docs/latest/application_documentation/rna/auto-drrafter) and a demo is available at <https://www.rosettacommons.org/demos/latest/public/auto-drrafter/README>. A limited version of the software is also freely available through an online ROSIE server at <https://rosie.rosettacommons.org/auto-drrafter>.

#### Data analysis

Chimera version 1.13.1, PyMOL version 1.8.4.2, python v2.7, EMAN2 version 2.22 (for auto-DRRAFTER modeling), ShapeKnots version 6.1, M2seq data analysis scripts (<https://github.com/ribokit/M2seq>), MATLAB version 2014b, Primerize webserver, MotionCor2 version 1.2.1, CTFIND4 version 4.1.13, Relion version 3.0.2, cryoSPARC version 2.0.20, EMAN2 version 2.3 (for cryo-EM data processing)

For manuscripts utilizing custom algorithms or software that are central to the research but not yet described in published literature, software must be made available to editors/reviewers. We strongly encourage code deposition in a community repository (e.g. GitHub). See the Nature Research [guidelines for submitting code & software](#) for further information.

### Data

Policy information about [availability of data](#)

All manuscripts must include a [data availability statement](#). This statement should provide the following information, where applicable:

- Accession codes, unique identifiers, or web links for publicly available datasets
- A list of figures that have associated raw data
- A description of any restrictions on data availability

Cryo-EM maps are available in the EMDDB with accession codes EMD-21831, EMD-21832, EMD-21833, EMD-21834, EMD-21835, EMD-21836, EMD-21838, EMD-21839, EMD-21840, EMD-21841, and EMD-21842. Models (best-case) are available in the PDB with accession codes 6WLI, 6WLK, 6WLL, 6WLM, 6WLN, 6WLO, 6WLQ, 6WLR, 6WLS, 6WLT, and 6WLU. Fully automated models are available in the supplementary data. M2-seq and mutate-map-rescue data is available in the RMDB with accession codes RB1UTR\_DMS\_0000, 243RNA\_DMS\_0000, ATPAPO\_DMS\_0000, ATPAMP\_DMS\_0000, U1SNRNA\_DMS\_0000, SCARNA6\_DMS\_0000, VCKTAPO\_DMS\_0000, VCKTGLY\_DMS\_0000, DPRGLN\_DMS\_0000, ETERNA3\_DMS\_0000, SPINACH\_DMS\_0000, FNKTAPO\_DMS\_0000, FNKTGLY\_DMS\_0000,

## Field-specific reporting

Please select the one below that is the best fit for your research. If you are not sure, read the appropriate sections before making your selection.

Life sciences       Behavioural & social sciences       Ecological, evolutionary & environmental sciences

For a reference copy of the document with all sections, see [nature.com/documents/nr-reporting-summary-flat.pdf](https://www.nature.com/documents/nr-reporting-summary-flat.pdf)

## Life sciences study design

All studies must disclose on these points even when the disclosure is negative.

Sample size	No sample-size calculation was performed. We selected a set of 18 functionally diverse RNA molecules to subject to the Ribosome pipeline. We chose this sample size to encompass RNA molecules that range in size (62-388 nucleotides) and to include RNA molecules that we did and did not expect to adopt well-defined three-dimensional structures.
Data exclusions	No data was excluded.
Replication	Several thousand auto-DRRAFTER models were built for each system described in this study and the top ten scoring models built into independent half maps generated from separate halves of the cryo-EM data are provided as supplementary information and deposited to the PDB. The convergence values listed in the text provide a quantitative measure of this variability. All attempts at replication were successful.
Randomization	Not applicable to this study. This study does not involve allocation of samples/organisms/participants into experimental groups.
Blinding	Blinding to group allocation is not applicable to this study. This study does not involve allocation of samples/organisms/participants into experimental groups.

## Reporting for specific materials, systems and methods

We require information from authors about some types of materials, experimental systems and methods used in many studies. Here, indicate whether each material, system or method listed is relevant to your study. If you are not sure if a list item applies to your research, read the appropriate section before selecting a response.

### Materials & experimental systems

n/a	Involvement in the study
<input checked="" type="checkbox"/>	<input type="checkbox"/> Antibodies
<input checked="" type="checkbox"/>	<input type="checkbox"/> Eukaryotic cell lines
<input checked="" type="checkbox"/>	<input type="checkbox"/> Palaeontology
<input checked="" type="checkbox"/>	<input type="checkbox"/> Animals and other organisms
<input checked="" type="checkbox"/>	<input type="checkbox"/> Human research participants
<input checked="" type="checkbox"/>	<input type="checkbox"/> Clinical data

### Methods

n/a	Involvement in the study
<input checked="" type="checkbox"/>	<input type="checkbox"/> ChIP-seq
<input checked="" type="checkbox"/>	<input type="checkbox"/> Flow cytometry
<input checked="" type="checkbox"/>	<input type="checkbox"/> MRI-based neuroimaging